

FOREWORD

Dear Honda User,
You have just purchased a Honda lawn mower and we thank you for your confidence in us.

This manual has been written to familiarise you with your mower, to enable you to use it in the best possible conditions and to carry out its maintenance.

Our aim is to make you benefit to the full from technological advances, from new equipment and materials and from our experience. This is why we regularly make improvements to our models. Thus, the specifications and information contained in this manual may be modified without prior notice and without obligation to update it.

If you have a problem, or if you have any questions concerning the mower, contact your supplying dealer or approved Honda dealer. Keep this manual handy so you can consult it at any time. If you sell the mower be sure that the manual accompanies it.

We recommend that you read the guarantee policy to fully understand your rights and responsibilities. The guarantee policy is a separate document provided by your dealer.

No reproduction, even partial, may be made of this publication without prior written authorisation.

SAFETY INSTRUCTIONS

For your own safety and operating comfort, it is highly recommended that you read this manual in full.

Pay attention to these symbols and their meaning:

⚠ WARNING :

Indicates a high risk of severe personal injury or death if instructions are not followed.

CAUTION:

• Indicates a possibility of personnel injury or equipment damage if instructions are not followed.

NOTE: Source of usefull information.

DESCRIPTION OF THE CODES USED IN THIS MANUAL

HRX426C - HRX476C	H X E	P D E	P X E	Q X E	R X E	S D E	S X E
Hydrostatic drive Selfpropelled	•						
Pushed		•	•				
Self-propelled with gearbox and rear roller Pushed and rear roller				•			
Self-propelled with gearbox						•	•
Blade brake		•				•	
Rotostop	•		•	•	•		•

The model of your machine is indicated on its "identification label", by a series of letters and figures (see page 3).

 _____
Write down your machine's serial number here

Write down your machine's model here



OWNER'S MANUAL

Original instructions

HRX426C - HRX476C

Lawn mower

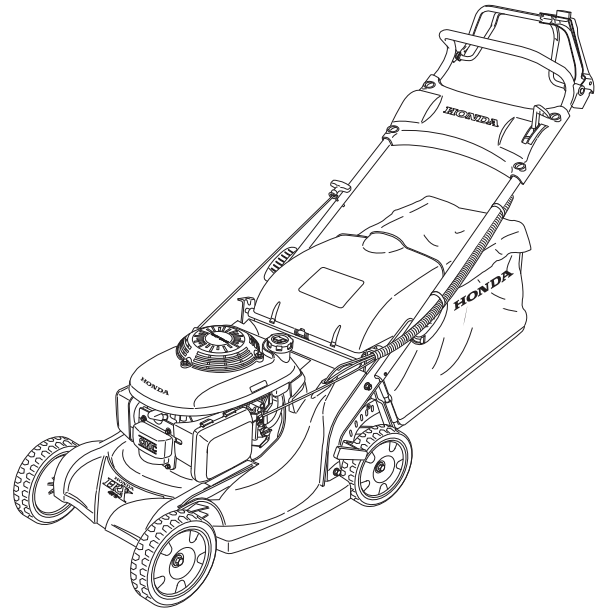

CONTENTS

Foreword	1
Safety instructions	2
Safety stickers	3
Identification of machine	3
General description	3
Preparations and checks before use	4
Starting and stopping the engine	6
Operating hints and tips	6
Maintenance	8
Troubleshooting	12
Storage	13
Transport	14
Useful Information	14
Technical specifications	15
Major Honda distributor addresses	17
EC-Declaration of conformity	18

ENGLISH

FRANCAIS

DEUTSCH

ITALIANO

NEDERLANDS

ESPAÑOL

SAFETY INSTRUCTIONS

Headings preceded by the following words must be read very carefully.

WARNING :

Indicates that there is danger of serious bodily injury or even death if instructions are not followed.

CAUTION:

• Indicates that there is a possible risk of bodily injury or equipment damage if instructions are not followed.

NOTE: Source of useful information.



This sign means that you must take care during certain operations. Refer to the safety instructions on the following pages, to the point(s) indicated in the box.

TRAINING

- A1. Read the instructions carefully. Be familiar with the controls and the proper use before using the equipment. Know how to stop the engine rapidly.
- A2. Use the mower for the purpose it is intended for, that is mowing and collecting grass. Any other use could be dangerous or damage the equipment.
- A3. Never allow children or people unfamiliar with these instructions to use the lawn mower. Local regulations may restrict the age of the operator.
- A4. Never mow when:
 - People, especially children or pets are nearby.
 - User is under medication or has swallowed substances known to affect judgement or reactions.
- A5. Keep in mind that the owner or user is responsible for accidents or hazards occurring to other people or their property.

PREPARATION

- B1. While mowing, always wear substantial footwear and long trousers. Do not operate the equipment when barefoot or wearing sandals.
- B2. Thoroughly inspect the area where the equipment is to be used and remove all objects which may be thrown by the machine (stones, branches, wires, bones, etc...).
- B3. **WARNING** - Petrol is highly flammable.
 - Store fuel in containers specifically designed for this purpose.
 - Refuel outdoors only, before starting the engine and do not smoke while refuelling or handling fuel.
 - Never remove the cap of the fuel tank or add petrol while the engine is running or when the engine is hot.
 - If petrol is spilled, do not attempt to start the engine but move the machine away from the area of spillage and avoid creating any source of ignition until petrol vapours are dissipated.
 - Replace all fuel tanks and container caps securely.
 - Before tipping the lawn mower to maintain the blade or drain oil, remove fuel from tank.
- B4. Replace faulty silencers.
- B5. Before use, always visually inspect the machine, especially to see that the blades, blade bolts and cutter assembly are not worn or damaged. Replace worn or damaged blades and bolts in sets to preserve balance.

OPERATION

- C1. Do not operate the engine in a confined space where dangerous carbon monoxide fumes can collect.
- C2. Mow only in daylight or in good artificial light.
- C3. Avoid operating the equipment in wet grass, where feasible.
- C4. While mowing, always keep the safety distance to the blade, which is provided by the handle length.
- C5. Walk, never run. Do not let yourself be pulled by the mower.
- C6. Always be sure of your footing on slopes. Mow across the face of slopes, never up and down.

- C7. Exercise extreme caution when changing direction on slopes.
- C8. Do not mow slopes of more than 20°.
- C9. Use extreme caution when pulling the lawn mower towards you.
- C10. Stop the blade if the lawn mower has to be tilted for transportation when crossing surfaces other than grass, and when transporting the lawn mower to and from the area to be mowed.
- C11. Never operate the lawn mower with defective guards or housings, or without safety devices such as deflectors and/ or grass catchers.
- C12. Do not change the engine governor settings or overspeed the engine.
- C13. Disengage all blade (models equipped with Rotostop) and drive clutches (self-propelled models) before starting the engine.
- C14. Start the engine carefully according to instructions and with feet well away from the blade.
- C15. Do not tilt the lawn mower when starting the engine. Start the mower on a level surface, free of high grass or obstacle.
- C16. Keep hands and feet away from the rotating parts. Do not start the engine when standing in front of the discharge opening.
- C17. Never pick up or carry a lawn mower while the engine is running.
- C18. Stop the engine and disconnect the spark plug cap in the following cases:
 - Before any operation under the cutter housing or the discharge tunnel.
 - Before checking, cleaning or working on the lawn mower.
 - After striking a foreign object. Inspect the lawn mower for damage and make repairs before restarting and operating the lawn mower again.
 - If lawn mower starts to vibrate abnormally. Check immediately the cause of the vibration and perform the necessary repair.
- C19. Stop the engine in the following cases:
 - Whenever you leave the lawn mower unattended.
 - Before refuelling.
- C20. Stop the blade (models equipped with Rotostop) or the engine in the following cases:
 - When installing or removing the grass bag.
 - Before adjusting the cutting height.
- C21. Reduce the throttle setting during engine shut-down. Close the fuel shut-off valve by turning the fuel shut-off valve.
- C22. Using any attachments other than those recommended in this manual may cause damage to your lawn mower, and such damage will not be covered by your guarantee.

MAINTENANCE AND STORAGE

- D1. Keep all nuts, bolts and screws tight to be sure the equipment is in safe working condition. Regular maintenance is an essential aid to user's safety and retaining a high level of performance.
- D2. Never store the equipment with petrol in the tank inside a building when vapours may reach an open flame, spark or high temperature source.
- D3. Allow the engine to cool before storing in any enclosure.
- D4. To reduce the fire hazard, keep the mower, especially the engine and silencer, the petrol storage area as well, free of grass, leaves, or excessive grease. Do not leave containers of vegetable matters in or near a building.
- D5. If the fuel tank has to be drained, this should be done outdoors, with a cold engine.
- D6. Check the grass collecting system frequently for wear or deterioration.
- D7. Do not use the machine with worn or damaged parts. Parts must be replaced, not repaired. Replace worn or damaged parts with Honda genuine parts. Blades must always bear the mark Honda and the reference number. Non equivalent quality parts may damage the machine and be prejudicial to your safety.
- D8. Wear thick gloves when removing or installing the blade or when cleaning the cutter housing. When tightening or loosening the blade screws, use a wooden block to prevent the blade from rotating.
- D9. Always make sure the correct balance of the blade when sharpening.

SAFETY STICKERS

Your lawn mower must be used with care. Therefore, decals have been placed on the machine, to remind you pictorially of main precautions to take during use. Their meaning is explained below. These decals are considered as a part of the mower. Should one become detached or unreadable, contact your Honda dealer for its replacement.

We also recommend that you read the safety advice on carefully (see page 2).

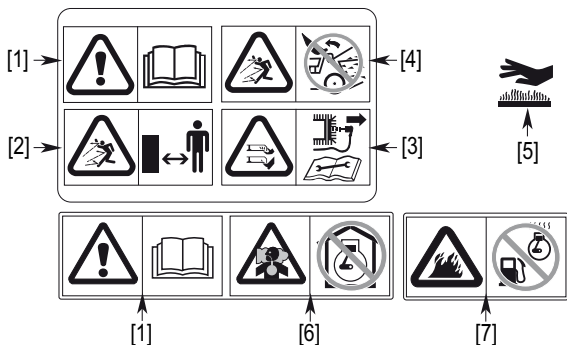

- [1] **WARNING:** Read the owner's manual before using the mower.
- [2] Risk of projections: Keep third persons away from the area during use.
- [3] Risk of cuts. Rotating blade: Do not put hands or feet inside the blade enclosure. Disconnect the spark plug cap before performing any operation of maintenance or repairs.
- [4] Do not operate without either discharge guard or grass catcher in place.
- [5] The muffler becomes very hot during operation and remains hot for a while after stopping the engine.
- [6] The engine emits toxic carbon monoxide. Do not run in an enclosed area.
- [7] Petrol is highly flammable. Stop the engine before refueling.

DESCRIPTION OF THE SYMBOLS USED IN THIS MANUAL

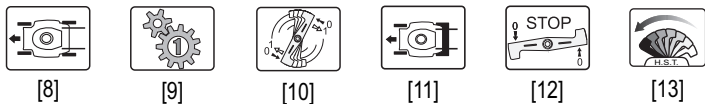

- [8] Four wheels models
- [9] 1-Speed gear box models
- [10] Models equipped with blade brake clutch (Rotostop)
- [11] Rear roller models
- [12] Models equipped with blade brake
- [13] Hydrostatic drive models (H.S.T)

IDENTIFICATION OF MACHINE

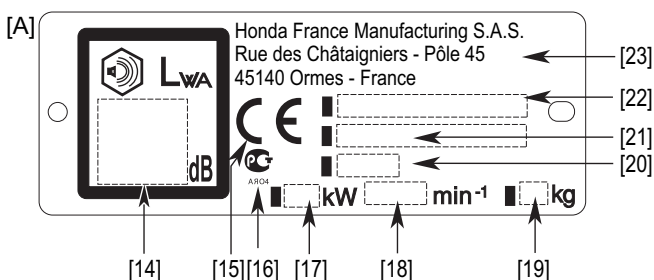

- [14] Acoustic power level according to the directives 2000/14/EC, 2005/88/EC
- [15] Conformity mark, according to the directives 98/37/EC, 2006/42/EC, 2000/14/EC, 2005/88/EC, 2004/108/EC
- [16] Russian conformity mark
- [17] Nominal power in kilowatt
- [18] Recommended engine speed in rpm
- [19] Mass in kilograms
- [20] Year of manufacture
- [21] Serial number
- [22] Model - Type
- [23] Name and address of the manufacturer

GENERAL DESCRIPTION

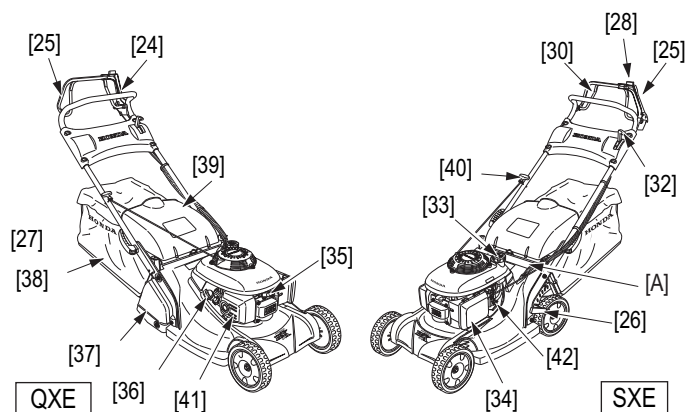
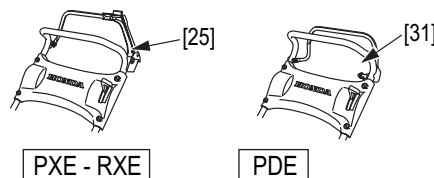
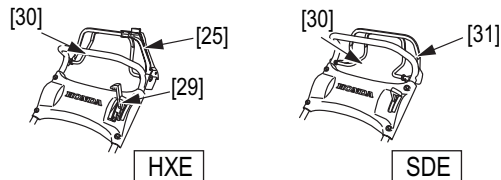

EQUIPMENT IDENTIFICATION

CONTROLS	FUNCTIONS
[24] Handle	
[25] Blade clutch lever (*)	Couple and stops the blade
[26] Lever for adjusting the cutting height	Selects the desired cutting height
[27] Lever for folding / adjusting the handle	Allows you to adjust the height of the handle or to fold the handle
[28] Blade clutch lever control button (*)	Activates blade clutch lever
[29] Variable speed control lever (*)	Controls the maximum drive speed
[30] Drive clutch lever (*)	Controls the transmission which drives the rear wheels or the rear roller
[31] Blade brake lever (*)	Stops the blade rotation and the engine / Authorises start-up
[32] Accelerator lever	Controls the engine speed
[33] Fuel tank	
[34] Air filter	
[35] Spark plug	
[36] Engine oil reservoir	
[37] Rear roller (*)	
[38] Grass bag	Collects the cut grass
[39] Discharge guard	Protects the projections
[40] Recoil	Allows you to start the engine
[41] Muffler	
[42] Fuel valve	Closes / opens the fuel circuit

(*) For the models equipped

PREPARATION AND CHECKS BEFORE USE



⚠ WARNING :

To carry out this series of checks, place the mower on stable and level ground with engine stopped and spark plug [1] cap removed.

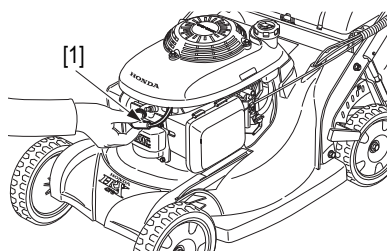

ASSEMBLY OF THE HANDLE

Before mounting the handle, ensure that the cables [2] are positioned outside the handle. Fit the components in the order indicated. Take care to position the cables above the handle [3]. Note the direction of assembly of the spring washers [4], with the convex side turned towards the nut [5].

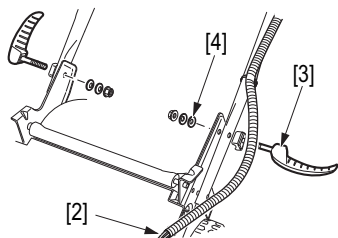

While holding the handle [3] in an open position, tighten the nut [5] until the thread is 2 mm [6] longer than the nut [5]. Choose the desired height and tighten the handles to lock the handle. If the effort to close down the handles [3] seems too important, untighten slightly the nuts [5]. If the clamping of the handle seems too weak, tighten the nut [5].

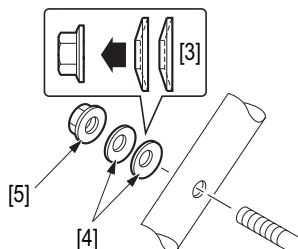

Ensure that the clamping rings for the cables on the handle are positioned correctly:

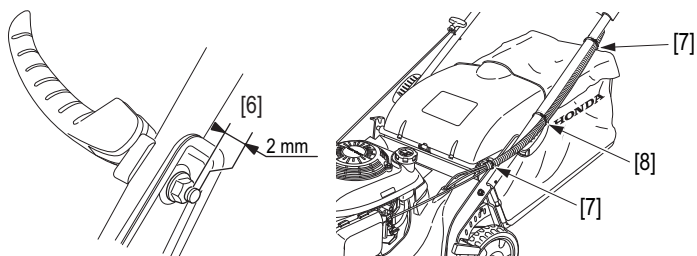

[7] at each end of the fluted tube [8] aligned with the center of the clamping handle

To assemble the grass bag, please refer to page 11.

CHECKING THE GRASS BAG

⚠ WARNING :

Before use, ensure that the bag closing device is correctly locked (discharge guard).



Even in normal use, the grass bag tends to wear. Regularly check that it is not frayed or torn. A worn out bag must be replaced. Replace a damaged bag by a Honda bag only.

Bag removal:

1. Stop the engine.
2. Raise discharge guard [9], grasp handle [10] and remove bag [11] while keeping it in an upright position.

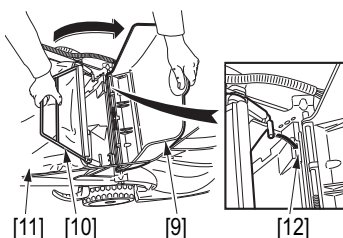

Bag fitting:

1. Raise the discharge guard and hook the front of the bag on the mower's attachment lugs [12].

NOTE:

- The HRX mower can be fitted with an optional mulching kit, available from your approved Honda reseller, comprising an additional special blade and a housing cap (see page 14).
- Mulching is a natural fertilisation technique. The grass is no longer collected in the grass bag, but is finely ground and deposited on the lawn. The grass cuttings chopped up in this way decompose in the sun and form a natural humus which can produce a quarter of the annual fertilisation requirement of your lawn.
- In addition to its fertilising role, mulching protects the ground, limits evaporation of water during hot periods and relieves you of the task of collecting the grass.

CHECKING FUEL LEVEL

⚠ WARNING :

Do not fill the fuel tank up to the brim (there must be no fuel in the filler neck). When filling is completed, ensure that the tank filler cap is screwed fully on.

Avoid getting fuel on the skin repeatedly or for long periods and avoid breathing fuel vapours. Keep fuel away from children.

CAUTION:

- Never use a gas-oil mixture.
- Only use unleaded petrol 95 or 98.
- Do not let dirt, clippings, etc. get into the tank.
- Do not use dirty or contaminated fuel (water, dust, ...), or fuel which is too old. The quality of unleaded petrol deteriorates with time. Do not keep fuel for more than one month (see page 13).

To check the fuel level:

1. Remove filler cap [13] and check fuel level.
2. Fill [14] tank if level is low. The maximum level is reached when the fuel is opposite mark [15].
3. Screw filler cap [13] fully on after filling.

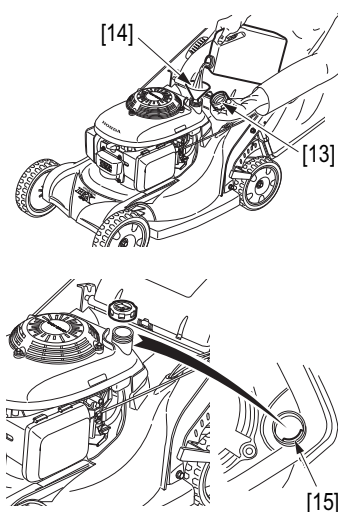

NOTE: Fuel substitute products are not recommended. These may damage fuel system components.

FUEL CONTAINING ALCOHOL

If you intend to use fuel with alcohol, ensure that its octane number is at least as high as that recommended by Honda (86). There are two types of fuel/alcohol mixtures: one contains ethanol and the other methanol.

Do not use mixtures containing more than 10% ethanol, or fuel containing methanol (methyl or wood alcohol), which do not contain cosolvents, or corrosion inhibitors for methanol.

In the case of a mixture containing methanol with addition of cosolvents and corrosion inhibitors, limit the proportion to 5% of methanol.

NOTE: The guarantee does not cover damage caused to the fuel system or engine performance problems resulting from the use of fuel containing alcohol. Honda does not give its approval to the use of fuels containing methyl alcohol since their suitability is not yet proven.

CHECKING THE AIR CLEANER

CAUTION:

- Never run the engine without the air cleaner fitted since this could cause premature engine wear.

To check the condition of the air cleaner:

- Press the latch tabs [1] on the top of the air cleaner cover and remove the cover [2].
- Check the cleanliness of filter element [3].
If the element is dirty, follow the cleaning procedure (see Maintenance chapter).
- Reinstall the filter [3] and air cleaner cover [2].

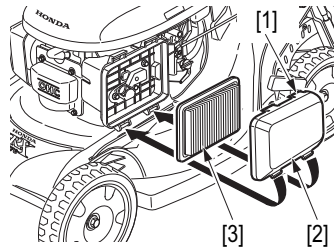

CHECKING BLADE CONDITION



CAUTION:

- Do not tilt the mower with the carburetor facing down; this will make the mower difficult to start later, due to engine oil contaminating the air cleaner.

To check blade condition:

- Stop the engine.
- Pull off the spark plug cap.
- Place the mower on its side so that the carburetor is facing upwards (left side [4]).
 - Check if the blade is showing signs of wear. For your information, it is necessary to replace the blade when the recesses join together, or when a crack appears.
 - Check that blade bolts are tight (see Maintenance chapter).
 - To replace or remove the blade, refer to the procedure described in the Maintenance chapter.

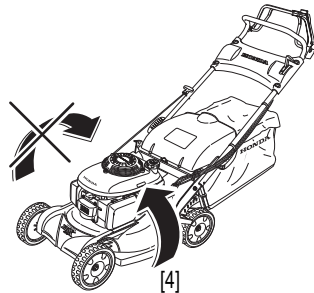

NEW BLADE

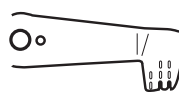

WORN BLADE

WARNING:

Never operate the mower with a worn, damaged, split or dented blade. A piece of blade which breaks off and is thrown outwards can cause serious bodily injuries.

NOTE: Blade wear is increased when the mower is used on sandy soils. Inspect the blade more often when the mower is used in these conditions.

ADJUSTING CUTTING HEIGHT

To change the cutting height:

- Stop the engine.
- Pull the adjusting lever [5] towards the outside of the machine.
- Turn the adjusting lever [5] left or right to move the wheels up or down to raise or lower the cutting height.

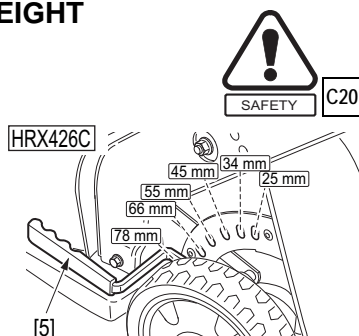

The cutting height settings are approximate values, the actual height of the cut grass varies with the lawn and ground condition. To choose the cutting height, check how the lawn looks after mowing a small area and adjust the cutting height where necessary.

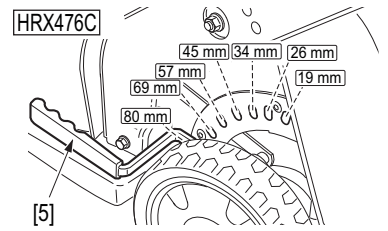

NOTE:

- Do not cut more than 1/3 of the initial height of the grass in one passage as brown spots will appear. The cut will be cleaner and this will limit the amount of jamming.
- If the lawn is too high, mow at the maximum permissible height of the mower. Mow the lawn again 2 or 3 days later.

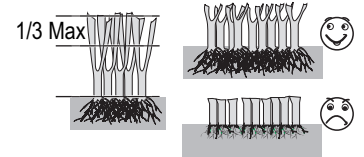
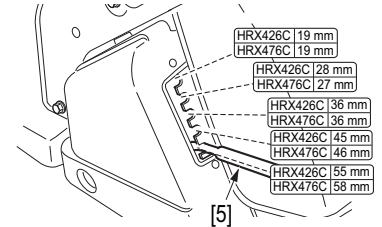

- The depth of the roots is proportional to the height of the grass cuttings: the shorter the cut, the shallower the roots.
- Choose a cutting height suited to the use of the lawn: leisure, sport: 5 cm or more, ornamental: 1 to 3 cm.
- Only some species of lawn can endure short cuts. If a lawn is cut too short, it is fragile and susceptible to dryness. Please ask the advice of a specialist.

CHECKING ENGINE OIL LEVEL

CAUTION:

- The engine oil is an essential element which affects the performance and lifetime of the engine.
- The engine may be seriously damaged if run with insufficient oil. We recommend the use of Honda 4-stroke oil or an equivalent quality engine oil which is highly detergent. Oil viscosity must be appropriate for the average temperature in the zone where the mower is to be used.

Types of oil [6] adapted to the ambient temperature [7].

To check engine oil level:

- Put the lawn mower on flat, even ground.

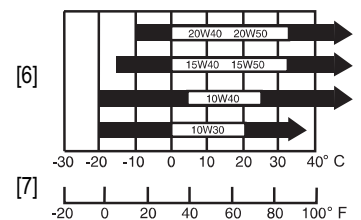

- Remove the oil filler cap and wipe the dipstick [8].
- Replace the dipstick in the filler neck but do not screw it down.

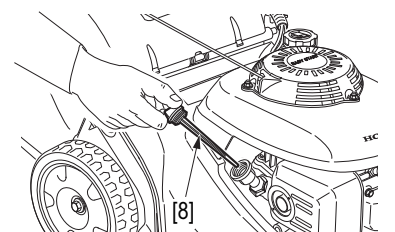

- Check the level of the oil left on the dipstick. If the level is near the low level mark [9], add the recommended oil up to the high level mark [10].
- Screw filler cap.

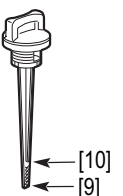

STARTING AND STOPPING THE ENGINE



STARTING THE ENGINE

CAUTION:

- Do not start the engine with the blade clutch lever or the drive clutch lever engaged.



[A]

CHOKE

For starting a cold engine.



[B]

FAST

For restarting a hot engine and for mowing.



[C]

SLOW

Selects engine idling speed.



[D]

STOP

Stops engine. (Rotostop models)

All models:

- Open the fuel cock [1].

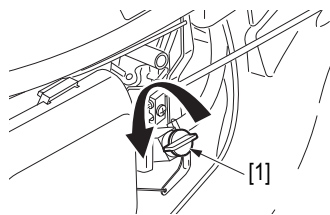

- Place the throttle lever [2] in "CHOKE" position [A].

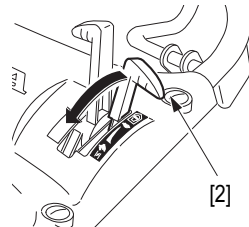

NOTE: Place the throttle lever in "FAST" position [B] when the engine is hot or the ambient temperature is high.



- Keep the blade brake lever held [3] firmly against the handle when starting the engine.

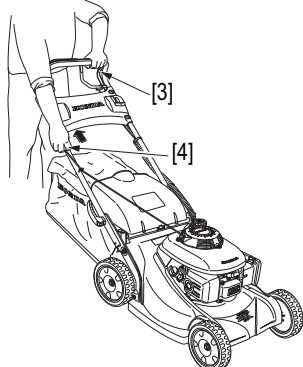

All models:

- Pull the starter [4] slowly until a resistance is felt; then pull sharply.

NOTE: Do not let the starter spring back suddenly on its own; guide it back slowly.

- Once the engine has warmed up (The engine runs evenly when the accelerator lever is moved away from the "CHOKE" position [A]), set the throttle lever to "FAST" position [B].

NOTE: To adjust the engine speed when the mower is running, the throttle lever can be set anywhere between the "FAST" [B] and "SLOW" [C] positions. However, the best results are obtained in the "FAST" position [B].



The engine may stall if the lever is in the "SLOW" position [C] when the blade clutch is engaged.

To facilitate starting, place the mower on a flat surface where the grass is not long.

STOPPING THE ENGINE



- Move the throttle control to the "STOP" position [D].



- Move the throttle control to the "SLOW" position [C].
- Release the flywheel brake lever.

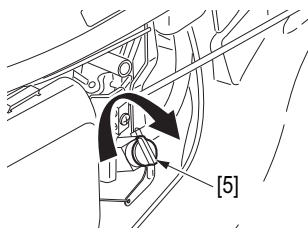

All models:

- Turn the fuel cock "OFF" [5].



FLOODED ENGINE

If the engine still refuses to start after several pulls on the starter, the engine may be flooded.

To clear a flooded engine:

- Place the throttle lever in "STOP" position [D] (Rotostop model).
- Remove and dry the spark plug. When refitting the spark plug, screw it up until it is finger tight and correctly seated. Then using the plug spanner, tighten it an additional 1/8 to 1/4 turn so that the washer is correctly compressed.
- Next, place the throttle lever in "FAST" position [B] and repeat the operations previously mentioned under the heading "Starting the engine".

OPERATING HINTS AND TIPS

USING THE MOWER AT HIGH ALTITUDES

At high altitudes, the standard fuel/air mixture in the carburetor is much too rich: this will reduce performance and increase fuel consumption.

It is possible to improve the high altitude performance by fitting the carburetor with a smaller diameter jet and by adjusting the pilot screw. If you use your mower at an altitude of more than 1500 meters above sea level, we recommend that you have these modifications made by your approved Honda dealer.

Even with the appropriate modifications made to the carburetor, engine power will be reduced by about 3.5% for every 300 meters of altitude. However, the altitude will have a much greater effect on power if these modifications are not carried out.

CAUTION:

- Running the mower at an altitude less than that for which the carburetor is adjusted may cause overheating and seriously damage the engine, due to the gas/air mixture being far too weak.

WARNING :

Take special care when mowing on uneven or irregular ground. The mower may tip over, thus uncovering the blade; also, the blade may throw out objects which were previously hidden. Keep the four wheels firmly on the ground.

Control the direction of the mower using the handle and not by exerting pressure on the blade casing with your foot.

CAUTION:

- When mowing around an obstacle, be careful that the blade does not hit it. Never push the mower directly over an object.
- When mowing an uneven area, do not let yourself be pulled along by the mower. Hold the handle firmly and control its advance.

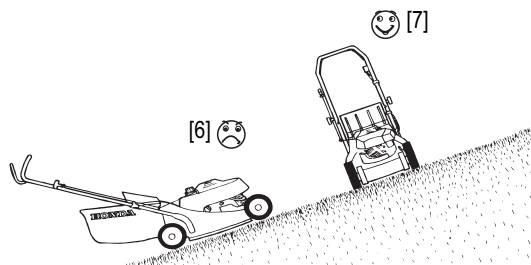

[6] WRONG

[7] RIGHT



NOTE: If the mower's speed becomes too slow when mowing on a slope, move the shift lever slightly towards the "FAST" position.

MOWING PROCEDURE



Read the safety instructions before starting to mow.



1. Place the mower in an obstacle-free area.

2.  The blade brake lever [1] must be held firmly against the handle for starting the engine.

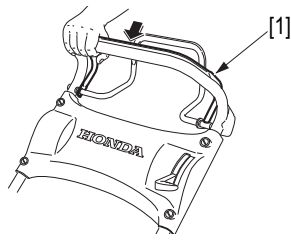

All models:

3. Start the engine, allow it to reach its maximum temperature and rotation speed.

4.  Select the suitable forward speed thanks to the shift lever [2].

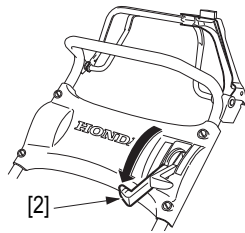

5.  Engage the blade: press the yellow button [3] located on the top of the blade control lever [4], and at the same time push it quickly and hold it against the handle.

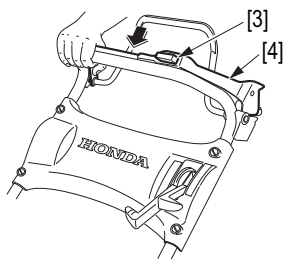

NOTE: For self-propelled models and Rotostop models, it is possible to refrain from using the forward drive while mowing in areas with a narrow surface.

Likewise, the drive clutch can be used to move the mower without engaging the blade clutch (lanes, borders, etc.).

CAUTION:

• Move the blade control lever quickly from one end of its travel to the other, so that the blade is always either fully engaged or fully disengaged. This is to avoid stalling the engine and increases the service life of the blade control mechanism.

⚠ WARNING :

Always release the blade clutch lever [4] and the drive clutch lever [5] before starting the engine. Starting is more difficult when the blade is engaged. If the clutch is engaged, the mower will move when the engine is started.

Except PDE, PXE, RXE:

6. Engage mower forward drive when the engine has built up speed: to start the mower moving, push the drive clutch lever [4] forward and hold it against handle.



NOTE:

• Move the drive clutch lever [5] quickly and completely so that the clutch is always fully engaged or fully disengaged. This avoids stalling the engine and increases the service life of the clutch mechanism.

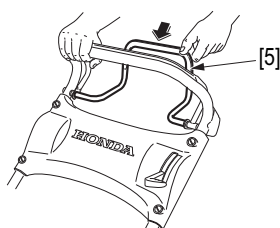

• The drive clutch lever [5] acts as a variable speed control according to its squeezed position. It makes the speed vary between zero and the maximal speed preset with the shift lever. The maximum speed can be reached when both levers [2] and [5] are pushed forward completely. The greater the height of the grass to be cut, the more it is necessary to reduce the drive speed of the machine. This will prevent overloading the engine and improve the quality of the cut.

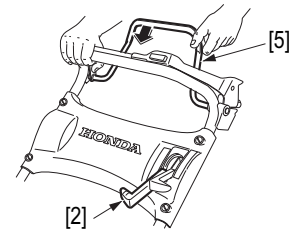

7. To stop the mower moving, release the clutch lever [12].

8. To stop the blade rotating:



• release the blade clutch control lever [4].

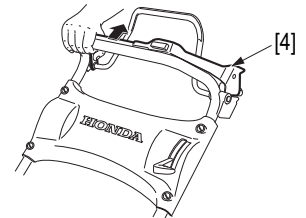

• release the flywheel brake lever [1].

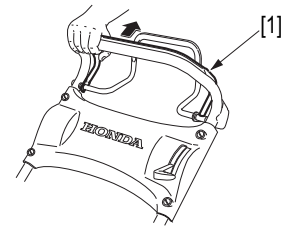

NOTE: Releasing the blade brake lever [1] stops the blade rotating and stops the engine.

NOTE:

- Mowing frequency: once a week for a lawn intended for leisure purposes, twice a week for an ornamental lawn.
- If possible, mow the lawn in the afternoon or evening before sprinkling, as the grass must be dry. If dust levels are too high, mow the lawn when the grass is dry, but the ground is still damp.
- Choose a cutting height adapted to the terrain (see page 5).
- For a regular cut, you should overlap the part that has already been cut by a few centimetres [6], and increase this overlap zone if the cutting height is high.
- To achieve maximum efficiency, follow the suggested path.
- If your terrain does not have a regular shape or involves several obstacles, divide it into internal parcels which you can mow in the recommended direction.

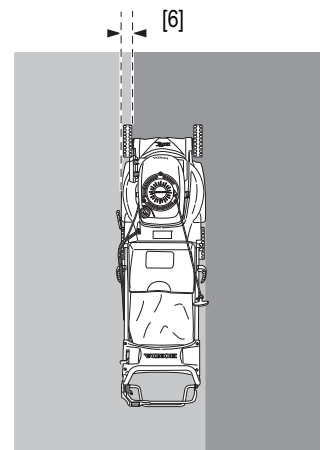

[7] With collection: turn in a clockwise direction to achieve the maximum efficiency.

[8] With the mulching kit (optional, page 14): turn in an anti-clockwise direction.

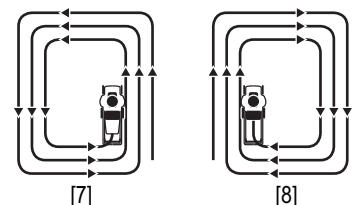

EMPTYING THE GRASS BAG

When the grass bag becomes too full, grass collection is no longer efficient (the sound of the mower changes and the bag is no longer puffed up by the air from the blade).



1. Stop the engine.
2. Remove the grass bag (see page 4).
3. Empty the bag:
 - Hold the bag by the metal handle [1].
 - Grasp handle [2] and shake the bag to remove the grass.

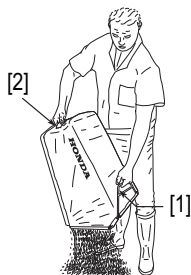

CAUTION:

- To reduce the fire risk, never leave grass cuttings or leaves in the grass bag, or in or near buildings. Decomposing vegetable matter causes a high temperature rise.

⚠ WARNING :

Before use, check that the bag closing device is correctly positioned (discharge guard).

MAINTENANCE

Regular maintenance is the guarantee of a long lifetime for your mower.

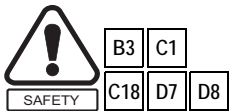

⚠ WARNING :

To avoid the mower starting accidentally, pull off the spark plug cap [3] before carrying out maintenance work.

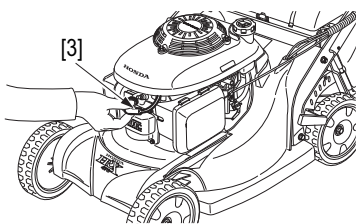

CAUTION:

- The engine and the muffler reach temperatures high enough to cause burns and start fires if flammable materials are to be found nearby.
- Allow the engine to cool down for 15 minutes before carrying out maintenance operations.

NOTE: To assure a longer lifetime and more efficient operation, the underside of the mower must be kept clean and free of grass debris by cleaning with a brush and scraper. After use the mower must be cleaned thoroughly before being stored.

AIR CLEANER MAINTENANCE

A dirty air cleaner will reduce the flow of air to the carburetor. To prevent the carburetor operating inefficiently, the air cleaner must be regularly maintained.

⚠ WARNING :

Never clean the air cleaner element using gas or flammable solvents; this could cause a fire or an explosion.

1. Press the latch tabs [4] on the top of the air cleaner cover, and remove the cover [5].
2. Inspect air filter [6] and replace it if it is damaged.
3. Tap the filter several times on a hard surface to remove dirt or blow compressed air (not exceeding 2.1 kgf/cm², 30 psi) through the filter from the clean side that faces the engine.

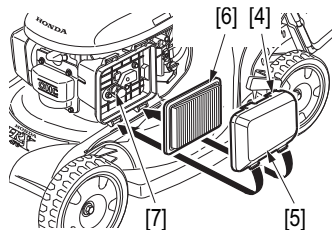

NOTE: The filtering element [6] must be dry in order to work correctly. Do not soak with oil.

4. Wipe dirt from the inside of the air cleaner cover [5] and clean case, using a moist rag.

NOTE: Be careful to prevent dirt from entering the air duct [7] that leads to the carburetor.

5. Reinstall the filter [6] and air cleaner cover [5].

ENGINE OIL CHANGE

Drain the oil while the engine is still hot, so that the oil drains quickly and completely.



CAUTION:

- Used engine oil can cause skin cancer if it remains in contact with the skin for long periods. Although this is highly unlikely unless you handle used oil every day, we recommend that you wash your hands thoroughly with soap and water each time you handle used engine oil.

1. Tip the mower on its side.
2. Place a receptacle [8] under the casing filler tube hole. And rock the mower on the right side.

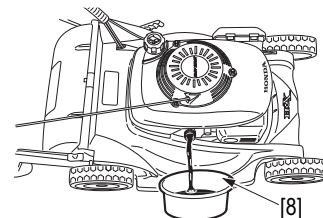

3. Remove the oil filler cap [9].
4. Return the mower to the upright position on its wheels when the casing is completely empty.

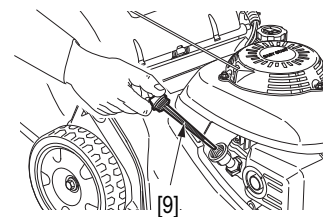

5. Fill up [10] to "high level" [11] using the recommended oil (see page 5).
6. Screw the filler cap fully on to avoid the risk of leaks.

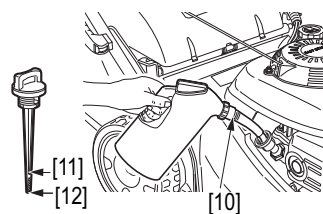

NOTE: The used engine oil must be disposed of in a manner which respects the environment. We recommend that you take it to a service station which will ensure that it is recycled. Never dispose of used engine oil in dustbins or pour it away on the ground, in the gutter or down the drains.

CHECKING THE SPARK PLUG

Recommended plugs: NGK - BPR5ES

CAUTION:

- Use only recommended spark plugs. Using spark plugs with inappropriate temperature ranges may damage the engine.

⚠ WARNING :

If the engine has just been run, do not touch the muffler and the spark plug which will still be very hot.

1. Pull off spark plug cap [13] and remove spark plug [14] using a plug spanner [15].

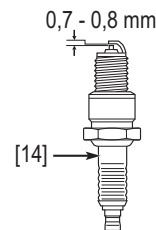
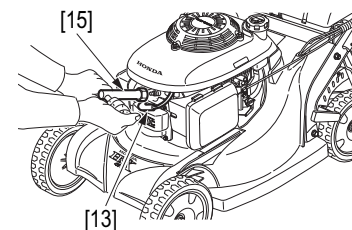

2. Carefully inspect the spark plug. Replace the plug if there are a lot of deposits or if the insulator is cracked or broken.
3. Measure the plug gap using a set of feeler gauges ; the gap must be between 0.7 and 0.8 mm. If adjustment is necessary, carefully bend the side electrode.
4. Check that the sealing washer is in good condition ; then screw the plug down by hand until finger tight and correctly seated.
5. Using a plug spanner, give an additional 1/2 turn for a new spark plug, to compress the washer. If you refit the same plug, just 1/8 to 1/4 turn will do from the finger tight position.
6. Refit the spark plug cap.

CAUTION:

- The spark plug must be correctly tightened. A plug incorrectly screwed down can become very hot and damage the engine.

MAINTENANCE OF SPARK ARRESTER (Optional part)

(In Europe and other countries where the machinery directive 2006/42/EC is enforced, this cleaning should be done by your servicing dealer).



WARNING :

If the mower has just been run, the silencer will still be very hot. Allow it to cool down before carrying out this operation.

In some regions, it is prohibited to operate an engine without a spark arrester.

1. Remove the three flange bolts [1] from the muffler protector [2] and remove the muffler protector.
2. Remove the two tapping screws [3] from the spark arrester [4] and remove the spark arrester from the muffler.
3. Check the carbon deposits around the exhaust port and spark arrester. Clean if necessary.
4. Replace the spark arrester if there are any breaks or tears.
5. Install the spark arrester [4] and muffler protector [2] in the reverse order of removal.

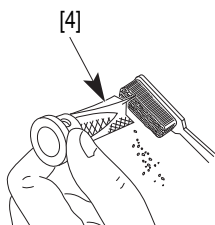
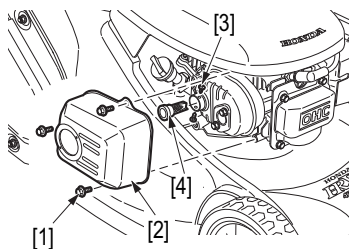

THROTTLE CONTROL CABLE ADJUSTMENT

1. Place the throttle lever [5] on "FAST" position [A].

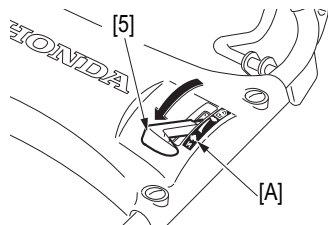

The arm [7] should touch the starter control [6] (clearance 0 to 1 mm).

2. If an adjustment is necessary, loosen the lock nut of the throttle cable and turn the adjuster as required to obtain the free play (0 to 1 mm). Tighten the lock nut securely. Place the throttle lever in the "STARTER" position and check whether the starter control [6] is completely raised.
3. Push the choke arm [8] with your finger to check whether it is all the way to the right.

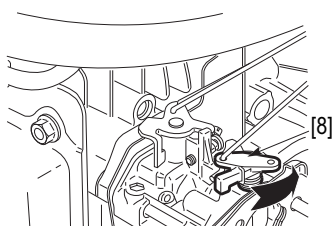
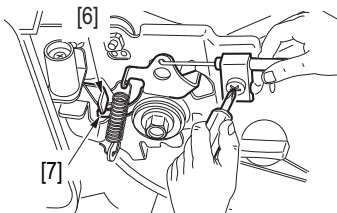

4. Start the engine and place the throttle lever on the "FAST" position. Make sure it stops when the throttle lever is moved to the "STOP" position.



All models:

4. Make sure the engine maximum and idle speeds are set correctly (see chapter Technical specifications).
5. Readjust the cable if necessary.

CAUTION:

- If you do not have the required skills or equipment, it is recommended to ask your Honda dealer for adjustment.



CARBURETOR ADJUSTMENT

1. Start the engine in the open air and allow it to reach its normal operating temperature.
2. Place the throttle lever in "SLOW" position
3. Screw the pilot screw [9] in or out until you reach the highest idle speed.
4. When the pilot screw is correctly adjusted, turn the throttle stop screw [10] to obtain the specified idle speed.

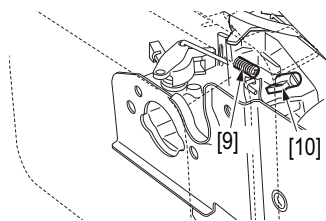

Specified idle speed: 1 700 ± 150 rpm

CAUTION:

- If you do not have the required skills or equipment, it is recommended to ask your Honda dealer for adjustment.



BLADE CLUTCH LEVER FREE PLAY

Measure the clearance [11] at the top of the lever [3] by holding the yellow button [12] pressed in.

It must be between 5 and 10 mm.

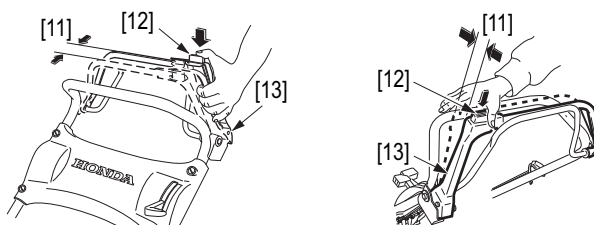

If necessary:

1. Undo the lock nuts [14] with a 10 mm spanner.
2. Move the nuts [14] up or down as necessary.
3. Retighten the lock nuts [14] and recheck the clearance.
4. Start the engine outdoors and engage the blade clutch lever. Check that the blade starts to rotate when you pull the lever to the rear, and that it stops rapidly when the lever is released. If the blade does not start to rotate or stop as it should, even when the cable is correctly adjusted, the system may need to be repaired. Take the mower to an approved Honda dealer.

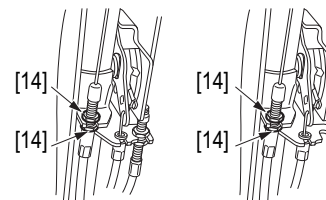



BLADE BRAKE CABLE ADJUSTMENT

1. Stop the engine and disconnect the spark plug cap.
2. Release the flywheel brake lever [6] and verify that there is a strong resistance when pulling on the recoil starter.

If not:

3. Measure clearance [7] at the tip of the lever [6] = 30-35 mm.

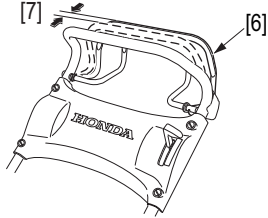

4. If adjustment is necessary, loosen the lock nuts [8] and adjust as required. Tighten the lock nuts and check the clearance again.

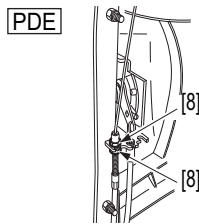

5. Start the engine and release the blade brake lever. Check that the blade and the engine stop when the lever is released. If not, take the mower to an approved Honda dealer.

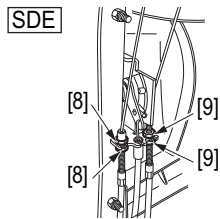

CLUTCH CABLE ADJUSTMENT

Measure the free play [10] on the side of lever [11] as shown.

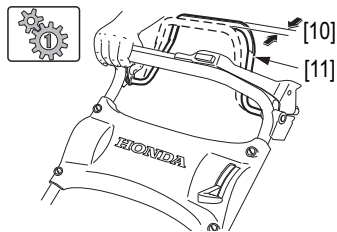

1. Place the gear stick in the fastest position and loosen the locknuts [12].

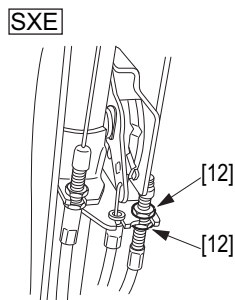

1. Loosen the locknuts [12] using a 10 mm spanner.
2. Relax or tighten the cable as necessary so that a free play of 1 to 5 mm is achieved.
3. Retighten the locknuts [12] and recheck the free play [10].
4. Start the engine in the open air and operate the clutch lever. Check that the clutch engages and disengages correctly.

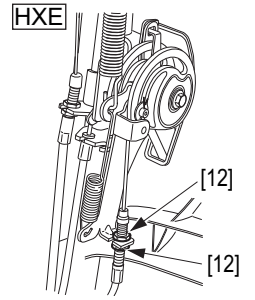

All models:

NOTE: If the clutch does not engage correctly even when the cable is correctly adjusted, the system may need to be repaired. Take the mower to an approved Honda dealer.

BLADE FITTING AND REMOVAL

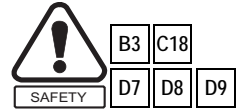

BLADE REMOVAL

1. Place the throttle lever in "STOP" position (Rotostop drive models).
2. Tip the mower so that the carburetor faces upwards [13].
3. Remove the bolts [14] from the blade [15] using a 14 mm socket wrench [18]. Use a wood block to stop the blade rotating when slackening the bolts.

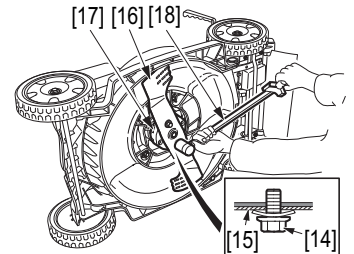
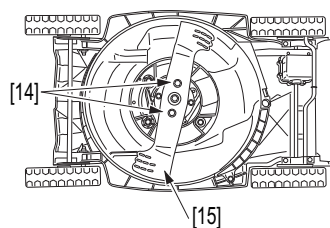
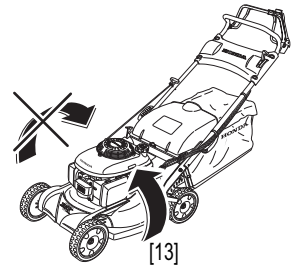

4. Remove the blade [15] from the blade holder [17].

NOTE: Never tip the mower so that the carburetor faces down; this will make starting difficult.

BLADE SHARPENING

1. Sharpen the blade cutting edges with a file. File the top side only. Maintain the original bevel for a fine cutting edge. File both ends evenly to maintain blade balance.
2. After sharpening, test the blade's balance using a screwdriver as shown. If either side dips slightly below the horizontal, file that side. Replace the blade if it dips excessively.

CAUTION:

- To avoid weakening the blade, causing it to become unbalanced or getting a bad quality of cut, the blade should be sharpened by competent personnel at your Honda dealer's.

BLADE REPLACEMENT

CAUTION:

- Blade balance is critical to proper mower performance. Replace any blade that is damaged or out of balance.
- Use only genuine Honda replacement blades.

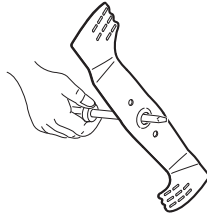

BLADE FITTING

1. Clean the dirt and grass from around the blade assembly area.

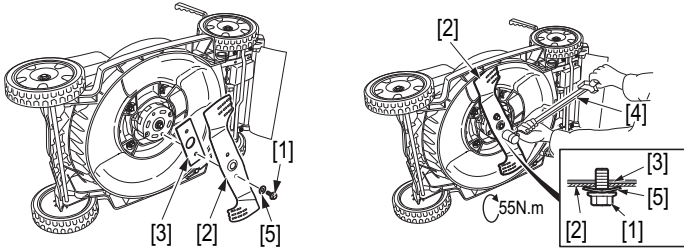

2. Fit the spacer [3] then the blade [2] using the 2 bolts [1] and the special washers [5] as illustrated. The blade bolts are specially designed for this usage. Do not use other bolts.
3. Retighten the blade bolts [1] using a torque wrench [4]. Use a wood block to stop the blade rotating when tightening the bolts.

Blade bolt tightening torque: 55 N.m

CAUTION:

- If you do not have a torque wrench, ask your approved Honda mower dealer to tighten the blade bolts for you before you use the mower.
- If the blade bolts are too tight or too slack, they may break or unscrew.

GRASS BAG CLEANING AND REPLACEMENT



BAG CLEANING

CAUTION:

- Washing with a high pressure water or steam jet will damage the bag.
- Blocked mesh will prevent the grass from entering the bag.
- To clean the bag, we recommend washing it using a water jet directed from the outside to the inside of the bag. The bag must be completely dry before being used again. If the bag is damp, it will become clogged very quickly.



⚠ WARNING :

Objects struck by the blade may be thrown through a torn or damaged grass bag.
Objects thrown out by the blade can cause serious injuries.
Always replace a torn or damaged grass bag.

BAG REPLACEMENT

The grass bag tends to wear even in normal conditions of use. Regularly check that it is not frayed or torn. Replace a damaged bag only by a genuine Honda replacement bag.

1. Detach the plastic edges [6] of the worn bag [8] and remove the bag's frame [7].

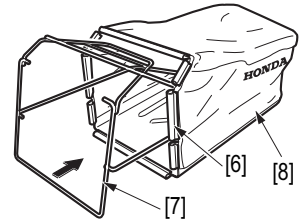

2. Insert the frame into the new bag and fit the plastic edges [6] to the frame.

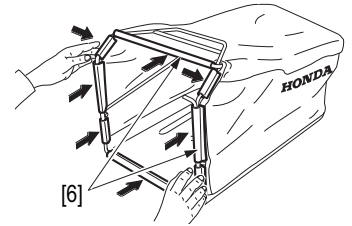

FORWARD DRIVE BELT CHECK (EXCEPT QXE)

⚠ WARNING :

To avoid all risks of serious injury, pull off the spark plug cap to prevent the engine starting accidentally, and wear thick gloves to protect your hands from the blade.



1. Move the throttle control to the "STOP" position .

All models:

2. Pull off the spark plug cap.
3. Tilt the mower so that the carburetor [9] (left side of mower) is facing upwards.

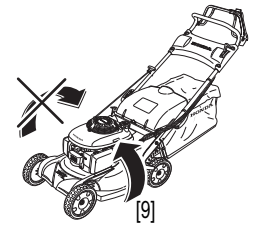

CAUTION:

- Never tilt the mower so that the carburetor side is facing downwards. Fuel will spill out and the mower will be difficult to start.

4. Unscrew the bolt [12] and the two bolts [13] as well as their washer [14]. Pull on the hook [15] and remove the scroll guide [11].
5. Check that the belt [10] is not torn, cracked or showing early signs of breaking. If a replacement is necessary, take the mower to an approved Honda dealer.

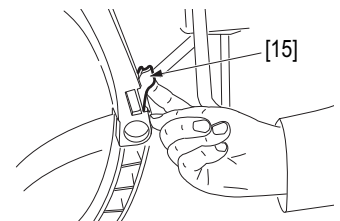
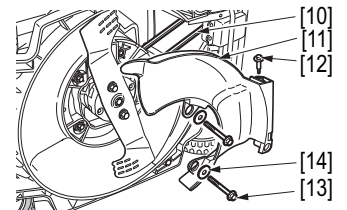

MAINTENANCE SCHEDULE

Maintenance to be carried out at the intervals indicated in months or in operating hours which ever occurs first.		Frequency					
		1 st service of the mower	Each use	First month or 5 hours	Every 3 months or 25 hours	Every 6 months or 50 hours	Every year or 100 hours
Item	Intervention						
Engine oil	Check level						
	Change						
Air cleaner element	Check						
	Clean				(1)		
	Change						(1)
Grass bag	Clean						
Blade screw tightness and blade condition	Check						
Spark plug	Check						
	Clean						
Spark arrester (Optional part)	Clean						(7)
ROTOSTOP cable (3)	Check	(2)		(2)		(2)	
	Adjust						
Blade brake cable (4)	Check						
	Adjust			(2)		(2)	
ROTOSTOP (3)	Check						
Shift cable (5)	Adjust						
Throttle cable	Check						
	Adjust						
Valve clearance	Check						(2)
	Adjust						(2)
Fuel tank and filter	Clean					(2)	
Fuel lines	Check (replace if necessary)	Every 2 years (2)					
Flywheel brake shoe (4)	Check					(2)	
Drive belt (5)	Check					(2)	
	Change						(2)
Roller driving chain	Check					(2)	
Rear roller bearing (6)	Check (replace if necessary)						(2)
	Grease						(2)

(1) Increase cleaning frequency when mower is used in dusty areas.

(2) Maintenance of these points must be carried out by a Honda dealer.

(3) Types : QXE, SXE, RXE, HXE, PXE

(4) Types : PDE, SDE

(5) Types : SDE, SXE, QXE, HXE

(6) Types : RXE, QXE

(7) In Europe and other countries where the machinery directive 2006/42/EC is enforced, this cleaning should be done by your servicing dealer.

TROUBLESHOOTING

Problem	Probable cause	Page
Engine does not start:	1. No gas.	4
	2. Throttle lever is in "STOP" position (models equipped rotostop).	6
	3. Spark plug cord incorrectly attached or disconnected.	8
	4. Spark plug defective or incorrect gap.	8
	5. Engine flooded.	6
	6. The blade brake lever is not firmly held against the handle (models fitted).	6
The engine smokes continuously:	1. Check the condition of the air filter (clogged).	5
Starting difficult or loss of power:	1. Impurities in fuel tank and/or fuel filter. Drain the reservoir. Refil with fresh fuel.	13
	2. Air cleaner dirty.	5
	3. Water in gas tank and in carburetor. Drain the reservoir. Refil with fresh fuel.	13
	4. Fuel tank filler cap vent and/or carburetor obstructed (*).	-
Uneven running:	1. Spark plug defective or incorrect gap.	8
	2. Air cleaner dirty.	5
Engine overheats:	1. Spark plug gap incorrect.	8
	2. Air cleaner dirty.	5
	3. Engine cooling fins clogged (*).	-
	4. Oil level too low.	5
	5. Starter pulley clogged by grass cuttings, etc (*).	-
Mower vibrates excessively:	1. Blade or engine bolts slack.	10
	2. Blade unbalanced.	10

(*) Maintenance of these points must be entrusted to an approved Honda dealer unless the user has the necessary tools and is mechanically competent.

STORAGE

PREPARATION FOR STORING THE MOWER

Carry out the following operations to protect the mower each time it is to be stored for a period of more than 30 days.

⚠ WARNING :

Do not drain the fuel tank while the muffler is hot.



1. Drain the fuel tank and the carburettor into a suitable receptacle [1].

- a. Open the fuel cock [2].



- b. Place the throttle control lever [3] in "FAST" position [A].

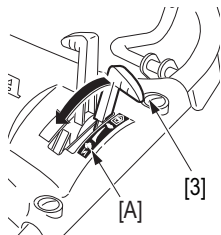

- c. Unscrew the carburettor float bowl retaining bolt [4] (1/4 to 1/2 turn maximum).

- d. Lift up the carburettor float bowl against the body of the carburettor [5] allowing the fuel to drain.

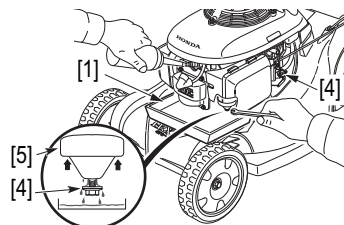

- e. Refit the drain plug and close the fuel shut-off valve [2].

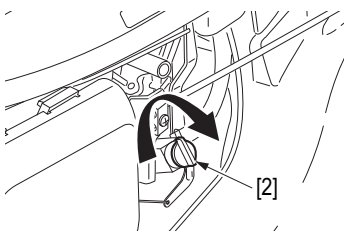

2. Change the engine oil (see page 8).
3. Pull the starter slowly until a resistance is felt. This closes the valves and protects them from dust and corrosion.
4. Coat all surfaces liable to rust with a thin film of oil. Cover the mower and store it on a flat surface in a dry, dust free place. Do not use a plastic cover since this retains dampness.

NOTE: If the mower is to be stored for a period of more than 3 months, remove the spark plug and pour 5 to 10 cc of clean engine oil into the cylinder ; then pull the starter slowly two or three times to spread the oil. Do not leave the mower lying on its side over long periods. This may cause difficult starting and gear oil leaks.

FUEL STORAGE

NOTE:

- Ensure that you use containers or drums specifically designed for hydrocarbons [8]. This will prevent polluting the fuel through the dissolution of the container walls, which will lead to poor functioning of the engine.
- The warranty does not cover a blocked carburetor or valves jammed by old or polluted fuel.
- The quality of unleaded petrol alters very quickly (2 to 3 weeks in some cases). Do not use fuel more than 1 month old. Store the absolute minimum required for your monthly consumption.

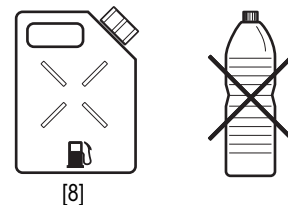

USING THE MOWER AFTER A STORAGE PERIOD

1. Remove the spark plug [6], check that it is clean and that the electrode gap is correct. Pull the starter several times.

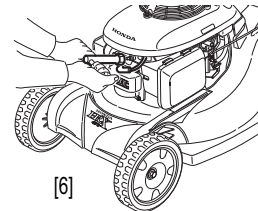

2. We recommend that the spark plug be screwed down as far as possible by hand until finger tight ; then use a plug spanner to tighten it by an extra 1/8 or 1/4 turn.

3. Check the level and condition of the engine oil [7].

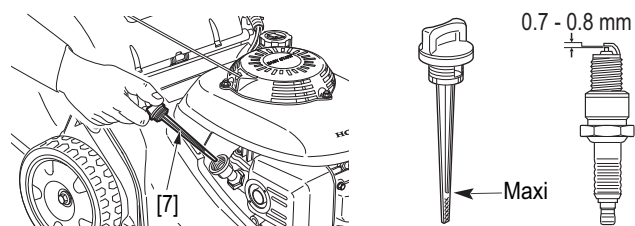

4. Fill the fuel tank and start the engine.

NOTE: If the cylinder has been coated with oil, the engine will smoke on start-up. This is normal.

TRANSPORT

TRANSPORTING THE MOWER



WARNING:

Do not tilt the mower since this may cause fuel or oil spillage; spilt fuel or even fuel vapours are a fire hazard.

To transport the mower:

1. Place the throttle lever in "STOP" position (except PDE, SDE types).
2. Pull off the spark plug cap.
3. Close the fuel shut-off valve [1].

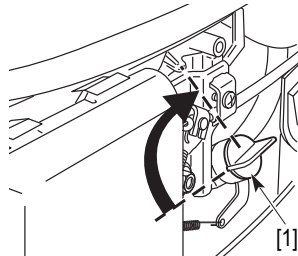

To facilitate the operation:

1. Remove the grass bag (see page 4).
2. Loosen the handle attachment knobs [2], pull out the adjustment stops [3] and fold the handle [4].

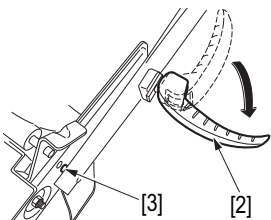

NOTE: After folding the handle, check that the cables are not kinked, twisted or stretched.

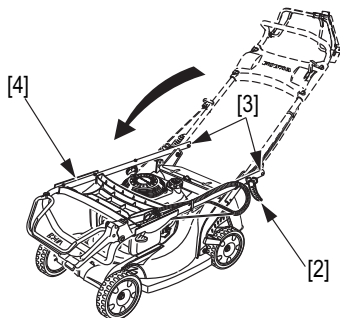

LOADING THE MOWER

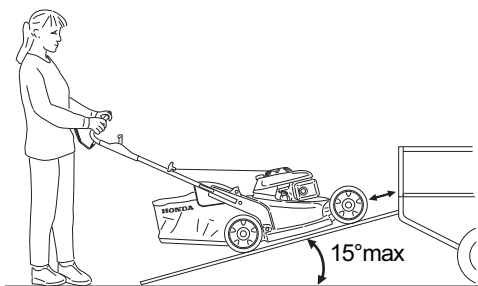

CAUTION:

- To prevent losing control of or damaging the mower, do not use the drive system when going up or down a loading ramp.
- To prevent damaging the drive system, do not engage the clutch when the mower is rolling backwards.
- Transport the mower in normal horizontal position with its four wheels flat on the vehicle platform.
- We recommend that you use a loading ramp or that you get someone to help you load and unload the mower.
- Adjust the loading ramp so that it is inclined at an angle of less than 15°.
- When transporting the mower, immobilise it using straps and place chocks under the wheels.
- The straps must not touch the following parts of the mower: throttle lever, blade clutch lever, gas tank and all the control cables.

USEFUL INFORMATION

FIND AN APPROVED DEALER

Please refer to the European Internet site:
<http://www.honda-eu.com>

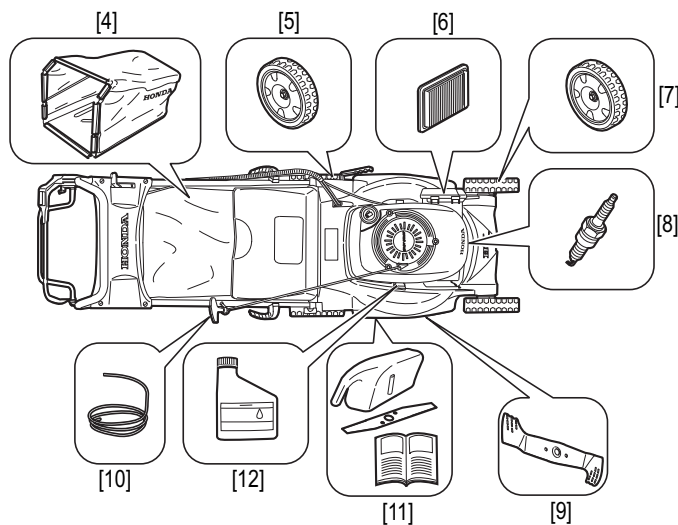

CURRENT PARTS, OPTIONAL ACCESSORIES AND CONSUMABLES

To buy one of the original parts listed below, or any other part, please contact an approved Honda reseller.

	HRX426C	HRX476C		
Current parts				
[4]	Grass bag	81320-VG8-A51	81320-VK8-003	Bag only (without frame)
[5]	Rear wheel	42700-VK8-753		
[6]	Air filter	17211-ZL8-013		Filter paper
[7]	Front wheel	44700-VK8-000		
[8]	Spark plug	98079-55846		NGK (brand) : BPR5ES (model)
[9]	Standard blade	72511-VK7-000	72511-VK8-000	Requires use of a dynamometric key
[10]	Recoil starter	28462-ZL8-631		Ask your Honda dealer to replace these
Optional part				
[11]	Mulching kit	06762-VK7-000	06762-VK8-000	1 upper blade, 1 plug, 1 Owner's Manual
Consumables				
[12]	Engine oil	08221-888-060HE SAE 10W30, 0,6 l		Oil for 4-stroke engines

WARNING:

For your safety, it is strictly prohibited to install any other attachment than the ones listed above and especially designed for your lawn mowers's model and type.



TECHNICAL SPECIFICATIONS

MODELS	HRX426C						
	SDE	SXE	QXE	RXE	PDE	PXE	
GENERAL CHARACTERISTICS							
Description code	MATF						
Function	Cutting of grass						
Dimensions L x W x h	mm	1 470 x 480 x 995	1 440 x 480 x 1 030	1 440 x 480 x 1 045		1 470 x 480 x 995	1 440 x 480 x 1 030
Dry weight	kg	33.5	36.5	38.5	34.5	31.5	34
Track FR/RR	mm	380/415		380/345	380/360	380/415	
Cutting width	mm	420					
Cutting heights settings	mm	6 positions (25 to 78 mm)		5 positions (19 to 55 mm)		6 positions (25 to 78 mm)	
Rear/Front wheel diameter	mm	200/200		200/90		200/200	
Grass bag capacity	l	60					
Sound pressure level at operator's ears (in accordance with directive EN836: 1997 / AC: 2006)	dB(A)	78					
Measuring uncertainty	dB(A)	1					
Measured sound power level (in accordance with directives 2000/14/EC, 2005/88/EC)	dB(A)	92					
Measuring uncertainty	dB(A)	1					
Sound power level guaranteed (in accordance with directives 2000/14/EC, 2005/88/EC)	dB(A)	94					
Vibration test (in accordance with directives EN836: 1997 / AC: 2006, EN12096-D: 1997)	m/s ²	5.2					
Measuring uncertainty	m/s ²	2.1					
ENGINE							
Model	GCV160E						
Type	Air-cooled overhead valve four-stroke engine						
Displacement	cc	160					
Bore x Stroke	64 x 50						
Cooling	Forced air						
Lubrication	Spray lubrication						
Compression ratio	8.5 : 1						
Net power (*)	kW/rpm	3.3 / 3 600					
Rated power	kW/rpm	2.8 / 2 900					
Operating speed	rpm	2 900 ⁺⁰ / ₋₁₀₀					
Idle speed	rpm	1 700 ± 150					
Ignition	Transistorised magneto ignition						
Spark plug	NGK : BPR5ES						
Electrode gap	mm	0.7 to 0.8					
Air cleaner	Dry (paper) type						
Recommended fuel	Unleaded 95 or 98						
Fuel tank capacity	l	0.93					
Fuel consumption	l/h	0.44					
Running time on tank of fuel (*)	h	2.1					
Recommended oil	SAE 10W30						
Engine oil capacity	l	0.55					
TRANSMISSION							
Type	Endless screw			-			
Engine to drive	V-belt			-			
Final transmission	Gear		Chain		-		
Main clutch	Dual cone clutch			-			
Number of speeds	Single speed			-			
Forward speed	m/s	0.95		0.9		-	
Lubrication	Oil bath and projection			-			
Recommended oil	15W40			-			
Oil capacity	cc	65		100		-	

(*) The power rating of the engine indicated in this document is the net power output tested on a production engine for the engine model GCV160E and measured in accordance with SAE J1349 at 3 600 rpm (Net Power). Mass production engines may vary from this value. Actual power output for the engine installed in the final machine will vary depending on numerous factors, including the operating speed of the engine in application, environmental conditions, maintenance, and other variables.

MODELS	HRX476C				
	SDE	SXE	QXE	HXE	PXE
GENERAL CHARACTERISTICS					
Description code	MASF				
Function	Cutting of grass				
Dimensions L x W x h	mm	1 530 x 530 x 1 005	1 520 x 530 x 1 050	1 520 x 530 x 1 055	1 520 x 530 x 1 050
Dry weight	kg	35.5	38.5	42	40.5 36
Track FR/RR	mm	420/455		420/393	420/455
Cutting width	mm	470			
Cutting heights settings	mm	7 positions (19 to 80 mm)		5 positions (19 to 58 mm)	7 positions (19 to 80 mm)
Rear/Front wheel diameter	mm	200/200		200/100	200/200
Grass bag capacity	l	73			
Sound pressure level at operator's ears (in accordance with directive EN836: 1997 / AC: 2006)	dB(A)	80			
Measuring uncertainty	dB(A)	1			
Measured sound power level (in accordance with directives 2000/14/EC, 2005/88/EC)	dB(A)	93			
Measuring uncertainty	dB(A)	1			
Sound power level guaranteed (in accordance with directives 2000/14/EC, 2005/88/EC)	dB(A)	94			
Vibration test (in accordance with directives EN836: 1997 / AC: 2006, EN12096-D: 1997)	m/s ²	5.6			
Measuring uncertainty	m/s ²	2.2			
ENGINE					
Model	GCV160E				
Type	Air-cooled overhead valve four-stroke engine				
Displacement	cc	160			
Bore x Stroke		64 x 50			
Cooling		Forced air			
Lubrication		Spray lubrication			
Compression ratio		8.5 : 1			
Net power (*)	kW/rpm	3.3 / 3 600			
Rated power	kW/rpm	2.7 / 2 750			
Operating speed	rpm	2 750 ^{+ 0} ₋₁₀₀			
Idle speed	rpm	1 700 ± 150			
Ignition		Transistorised magneto ignition			
Spark plug		NGK : BPR5ES			
Electrode gap	mm	0.7 to 0.8			
Air cleaner		Dry (paper) type			
Recommended fuel		Unleaded 95 or 98			
Fuel tank capacity	l	0.93			
Fuel consumption	l/h	0.34			
Running time on tank of fuel (*)	h	2.7			
Recommended oil		SAE 10W30			
Engine oil capacity	l	0.55			
TRANSMISSION					
Type		Endless screw		Hydrostatic	-
Engine to drive		V-belt			-
Final transmission		Gear	Chain	Direct	-
Main clutch		Dual cone clutch		Drain valve	-
Number of speeds		Single speed		Continuous variation	-
Forward speed	m/s	0.97	1.0	0 ~ 1.3 ± 0.1	-
Lubrication		Oil bath and projection		Oil bath	-
Recommended oil		15W40		Honda HST	-
Oil capacity	cc	65	100	140	-

(*) The power rating of the engine indicated in this document is the net power output tested on a production engine for the engine model GCV160E and measured in accordance with SAE J1349 at 3 600 rpm (Net Power). Mass production engines may vary from this value. Actual power output for the engine installed in the final machine will vary depending on numerous factors, including the operating speed of the engine in application, environmental conditions, maintenance, and other variables.

Major Honda distributor addresses

Adresses des principaux concessionnaires Honda

Adressen der wichtigsten Honda-Haupthändler

Elenco dei maggiori distributori Honda in Europa

Adresen van Honda-importeurs

Direcciones de los principales concesionarios Honda

AUSTRIA

Honda Motor Europe (North)
Hondastraße 1
2351 Wiener Neudorf
Tel. : +43 (0)2236 690 0
Fax : +43 (0)2236 690 480
<http://www.honda.at>

BALTIC STATES

(Estonia / Latvia / Lithuania)
Honda Motor Europe Ltd.
Estonian Branch
Tulika 15/17
10613 Tallinn
Tel. : 372 6801 300
Fax : 372 6801 301
✉ honda.baltic@honda-eu.com

BELGIUM

Honda Motor Europe (North)
Doornveld 180-184
1731 Zellik
Tel. : 32 26 20 10 00
Fax : 32 26 20 10 01
<http://www.honda.be>
✉ bh_pe@honda-eu.com

BULGARIA

Kirov Ltd.
49 Tsaritsa Yoana blvd
1324 Sofia
Tel. : +359 2 93 30 892
Fax : +359 2 93 30 814
<http://www.kirov.net>
✉ honda@kirov.net

CROATIA

Hongoldonia d.o.o.
Jelkovecka Cesta 5
10360 Sesvete – Zagreb
Tel. : +385 1 2002053
Fax : +385 1 2020754
<http://www.hongoldonia.hr>
✉ jure@hongoldonia.hr

CYPRUS

Alexander Dimitriou & Sons Ltd.
162 Yiannos Kranidiotis avenue
2235 Latsia, Nicosia
Tel. : + 357 22 715 300
Fax : + 357 22 715 400

CZECH REPUBLIC

BG Technik cs, a.s.
U Zavodiste 251/8
15900 Prague 5 - Velka Chuchle
Tel. : +420 2 838 70 850
Fax : +420 2 667 111 45
<http://www.honda-stroje.cz>

DENMARK

Tima Products A/S
Tårnfalkevej 16
2650 Hvidovre
Tel. : +45 36 34 25 50
Fax : +45 36 77 16 30
<http://www.tima.dk>

FINLAND

OY Brandt AB.
Tuupakantie 7B
01740 Vantaa
Tel. : +358 20 775 7200
Fax : +358 9 878 5276
<http://www.brandt.fi>

FRANCE

Honda Relations Clients
TSA 80627
45146 St Jean de la Ruelle Cedex
Tel. 02 38 81 33 90
Fax. 02 38 81 33 91
<http://www.honda-fr.com>
✉ espaceclient@honda-eu.com

GERMANY

Honda Motor Europe (North) GmbH
Spredlinger Landstraße 166
63069 Offenbach am Main
Tel. : +49 69 8309-0
Fax : +49 69 8320 20
<http://www.honda.de>
✉ info@post.honda.de

GREECE

General Automotive Co S.A.
71 Leoforos Athinon
10173 Athens
Tel. : +30 210 349 7809
Fax : +30 210 346 7329
<http://www.honda.gr>
✉ info@saracakis.gr

HUNGARY

Motor.Pedo Co., Ltd.
Kamaraerdei út 3.
2040 Budaors
Tel. : +36 23 444 971
Fax : +36 23 444 972
<http://www.hondakisgepek.hu>
✉ info@hondakisgepek.hu

ICELAND

Bernhard ehf.
Vatnagardar 24-26
104 Reykjavik
Tel. : +354 520 1100
Fax : +354 520 1101
<http://www.honda.is>

IRELAND

Two Wheels Ltd.
M50 Business Park, Ballymount
Dublin 12
Tel. : +353 1 4381900
Fax : +353 1 4607851
<http://www.hondaireland.ie>
✉ service@hondaireland.ie

ITALY

Honda Italia Industriale S.p.A.
Via della Cecchignola, 5/7
00143 Roma
Tel. : +848 846 632
Fax : +39 065 4928 400
<http://www.hondaitalia.com>
✉ info.power@honda-eu.com

MALTA

The Associated Motors Company Ltd.
New Street in San Gwakklin Road
Mriehel Bypass, Mriehel QRM17
Tel. : +356 21 498 561
Fax : +356 21 480 150

NETHERLANDS

Honda Motor Europe (North)
Afd. Power Equipment-Capronilaan 1
1119 NN Schiphol-Rijk
Tel. : +31 20 7070000
Fax : +31 20 7070001
<http://www.honda.nl>

NORWAY

Berema AS
P.O. Box 454
1401 Ski
Tel. : +47 64 86 05 00
Fax : +47 64 86 05 49
<http://www.berema.no>
✉ berema@berema.no

POLAND

Aries Power Equipment Sp. z o.o.
ul. Wroclawska 25
01-493 Warszawa
Tel. : +48 (22) 861 4301
Fax : +48 (22) 861 4302
<http://www.ariespower.pl> - www.mojahonda.pl
✉ info@ariespower.pl

PORTUGAL

Honda Portugal, S.A.
Rua Fontes Pereira de Melo 16
Abrunheira, 2714-506 Sintra
Tel. : +351 21 915 53 33
Fax : +351 21 915 23 54
<http://www.honda.pt>
✉ honda.produtos@honda-eu.com

REPUBLIC OF BELARUS

Scanlink Ltd.
Kozlova Drive, 9
220037 Minsk
Tel. : +375 172 999 090
Fax : +375 172 999 900
<http://www.hondapower.by>

ROMANIA

Hit Power Motor Srl
Calea Giulesti N° 6-8 - Sector 6
060274 Bucuresti
Tel. : +40 21 637 04 58
Fax : +40 21 637 04 78
<http://www.honda.ro>
✉ hit_power@honda.ro

RUSSIA

Honda Motor RUS LLC
21, MKAD 47 km., Leninsky district.
Moscow region, 142784 Russia
Tel. : +7 (495) 745 20 80
Fax : +7 (495) 745 20 81
<http://www.honda.co.ru>
✉ postoffice@honda.co.ru

SERBIA & MONTENEGRO

Bazis Grupa d.o.o.
Grcica Milenka 39
11000 Belgrade
Tel. : +381 11 3820 295
Fax : +381 11 3820 296
<http://www.hondasrbija.co.rs>

SLOVAK REPUBLIC

Honda Slovakia, spol. s r.o.
Prievozská 6 - 821 09 Bratislava
Tel. : +421 2 32131112
Fax : +421 2 32131111
<http://www.honda.sk>

SLOVENIA

AS Domzale Moto Center D.O.O.
Blatnica 3A
1236 Trzin
Tel. : +386 1 562 22 42
Fax : +386 1 562 37 05
<http://www.as-domzale-motoc.si>

SPAIN & LAS PALMAS PROVINCE

(Canary Islands)
Greens Power Products, S.L.
Avda. Ramon Ciurans, 2
08530 La Garriga - Barcelona
Tel. : +34 3 860 50 25
Fax : +34 3 871 81 80
<http://www.hondaencasa.com>

SWEDEN

Honda Nordic AB
Box 50583 - Väst kustvägen 17
20215 Malmö
Tel. : +46 (0)40 600 23 00
Fax : +46 (0)40 600 23 19
<http://www.honda.se>
✉ hepsinfo@honda-eu.com

SWITZERLAND

Honda Suisse S.A.
10, Route des Moulières
1214 Vernier - Genève
Tel. : +41 (0)22 939 09 09
Fax : +41 (0)22 939 09 97
<http://www.honda.ch>

TENERIFE PROVINCE

(Canary Islands)
Automocion Canarias S.A
Carretera General del Sur, KM 8.8
38107 Santa Cruz de Tenerife
Tel. : 34 (922) 620 617
Fax : 34 (922) 618 042
<http://www.aucasa.com>
✉ ventas@aucasa.com
✉ taller@aucasa.com

TURKEY

Anadolul Motor Uretim ve Pazarlama AS
Esentepe mah. Anadolu
Cad. No: 5
Kartal 34870 Istanbul
Tel. : +90 216 389 59 60
Fax : +90 216 353 31 98
<http://anadolulmotor.com.tr>
✉ antor@antor.com.tr

UKRAINE

Honda Ukraine LLC
101 Volodymyrska Str. Build. 2
Kyiv 01033
Tel. : +380 44 390 14 14
Fax : +380 44 390 14 10
<http://www.honda.ua>
✉ cr@honda.ua

UNITED KINGDOM

Honda (UK) Power Equipment
470 London Road
Slough - Berkshire, SL3 8QY
Tel. : +44 (0)845 200 8000
<http://www.honda.co.uk>

ЕС - Декларация за съответствие

- Долуподписалият се Г-н Канемур, представляващ производителя, с настоящия документ декларира че машина описана по-долу е в съответствие с всички изисквания на директивите за машини и съоръжения - Съоръжението също съответства с изискванията на:
- Директива за нивото на шума: - EMC директива:
- Описание на оборудването:
а) Общо наименование: косачка б) Функция: косене на трева
в) Тип: д) Серийен номер:
- Външен шум:
а) измерена сила на звука - б) максимална сила на звука - в) параметри на шума; нетна инсталирана мощност - д) процедура на измерването - е) измерено на купе
- Производител:
- Оторизиран представител, който може да съставя техническата документация:
- Съответствие с хармонизирани етандарти:
- Други национални стандарти и спецификации:
Място на изготвяне: Дата на изготвяне: Мениджър по качество: Подпис:

EC - Prohlášení o shodě

- Zástupce výrobce, Takayoshi Fukai svým podpisem potvrzuje, že daný výrobek splňuje požadavky Směrnice pro strojní zařízení Daný výrobek rovněž splňuje požadavky následujících Směrnic:
- hluková směrnice: - směrnice pro elektromagnetickou kompatibilitu:
- Popis zařízení:
а) Všeobecné označení: Sekačky na trávu б) Funkce: Sekání trávy
с) Typ: д) Výrobní číslo:
- Hluková směrnice:
а) Naměřený akustický výkon - б) Garantovaný akustický výkon
с) Parametry: Nominální výkon - д) Způsob stanovení shody - е) Notifikovaná osoba:
- Výrobce:
- Autorizovaná osoba pověřená schvalováním technické dokumentace:
- Odkazy na harmonizované normy:
- Ostatní použité národní normy a specifikace:
Podepsáno v: Datum: Prezident: Podpis:

EG-Konformitätserklärung

- Der Unterzeichner, Takayoshi Fukai der den Hersteller vertritt, erklärt hiermit dass die unten genannte Maschine den Bestimmungen aller relevanten Maschinenrichtlinien entspricht. Die Maschine entspricht ebenfalls den Vorschriften der:
- Outdoor Richtlinie: - EMV Richtlinie:
- Beschreibung der Maschine:
а) Allgemeine Bezeichnung: Rasenmäher б) Funktion: Gras schneiden
с) Typ: д) Seriennummer:
- Richtlinie zu Geräuschemissionen im Freien:
а) Gemessener Schalleistungspegel - б) Garantierter Schalleistungspegel - в) Geräusch Vorgabe: Tatsächliche Leistung - д) Angewandtes Konformitätsbewertungsverfahren
е) Benannte Stelle
- Hersteller:
- Bevollmächtigter zur Erstellung der technischen Unterlagen:
- Verweis auf harmonisierte Normen:
- Andere herangezogene nationale Normen, Bestimmungen oder Vorschriften:
Ort: Datum: Präsident: Unterschrift:

EU Overenstemmelseerklæring

- Undertegnede, Takayoshi Fukai, som repræsenterer producenten erklærer herved, at produktet beskrevet nedenfor opfylder alle retningslinier i maskindirektivet. Produktet opfylder også bestemmelserne i:
- Direktiv om støjemission fra maskiner til udedørs brug: - EMC direktiv:
- Beskrivelse af produktet:
а) Fællesbetegnelse: Plæneklipper б) Anvendelse: Græsklipning
с) Type: д) Stelnummer:
- Direktiv om støjmission fra maskiner til udedørs brug:
а) Målt støjniveau - б) Garanteret støjniveau - в) Støjparameter: Installeret motoreffekt
д) Overenstemmelsens vurderingsprocedure - е) Bemyndiget organ
- Producent:
- Autoriseret repræsentant for udfærdigelsen af den tekniske dokumentation:
- Reference til harmoniserede standarder:
- Andre nationale standarder eller specifikationer:
Sted: Dato: Formand: Underskrift:

Declaracion de conformidad CE.

- El firmante, Takayoshi Fukai, en representación del fabricante, adjunto declara que la máquina descrita más abajo cumple con todas los requisitos relevantes de la Directiva de Maquinaria. La máquina también cumple con los requisitos de la:
- Directiva sobre Ruido exterior: - Directiva EMC:
- Descripción de la máquina:
а) Denominación genérica: Cortacésped б) Función: Cortar el césped
с) Tipo: д) Número serie:
- Directiva Ruido Exterior:
а) Potencia medida sonido - б) Potencia sonido garantizada - в) Parámetros ruido: Potencia neta instalada - д) Procedimiento valoración conformidad - е) Organismo notificado.
- Fabricante:
- Representante autorizado para recopilar la Documentación Técnica:
- Referencia de los estándar armonizados:
- Otros estándar nacionales o especificaciones:
Realizado en: Fecha: Presidente: Firma:

EÜ Vastavusavaldus

- Allakirjutanu, Takayoshi Fukai, kinnitab tootja volitatud esindajana, et alltoodud seadmed vastavad kõikidele Tehniliste seadmete direktiivnõuetele. Lisaks selle vastavad seadmed järgmiste direktiivide nõuetele:
- Müratase väärtingimustes: - EMC direktiiv:
- Seadmete kirjeldus:
а) Üldnimetus: Muruniiduk б) Funktsioon: Muri niitmine
с) Tüüp: д) Seerianumber:
- Müratase väärtingimustes:
а) Mõõdetav helivõimsuse tase - б) Tegelik helivõimsuse tase - в) Mõra mõjutavad tegurid: Toite võimsus - д) Vastavushindamise menetlus - е) Teavitatud asutus
- Tootja:
- Volitatud esindaja, kes on kvalifitseeritud koostama tehnilist dokumentatsiooni:
- Viide ühtlustatud standarditele:
- Siseriiklikud seadusaktid:
Koht: Kuupäev: President: Allkiri:

Déclaration CE de conformité

- Le soussigné, Mr Takayoshi Fukai, représentant du constructeur, déclare par la présente que la machine décrite ci-dessous est conforme aux dispositions de la Directive Machine. Cette machine répond également aux dispositions de :
- Directive relative aux émissions sonores dans l'environnement des matériels destinés à être utilisés à l'extérieur des bâtiments :
- Directive relative à la compatibilité électromagnétique des équipements électriques et électroniques :
- Description de la machine :
а) Denomination générique : Tondeuse à gazon б) Fonction : Couper de l'herbe (tondre)
с) Type : д) Numéro de série :
- Directive relative aux émissions sonores dans l'environnement des matériels destinés à être utilisés à l'extérieur des bâtiments :
а) Puissance acoustique mesurée б) Puissance acoustique garantie в) Paramètres de bruit: Puissance nette installée д) Procédure d'évaluation de la conformité е) Organisme notifié.
- Constructeur :
- Représentant autorisé à valider la documentation technique :
- Référence aux normes harmonisées :
- Autres normes et spécifications techniques nationales :
Fait à : Date : Président : Signature :

EU-vaatimusten mukaisuusvakuutus

- Allekirjoittanut valmistajan edustaja Takayoshi Fukai vakuuttaa täten, että tuote on kaikkien EU: n konedirektiivin vaatimusten mukainen. Tuote on lisäksi seuraavien EU: n direktiivien vaatimusten mukainen:
- Meludirektiivi: - sähkömagneettista yhteensopivuutta koskeva direktiivi:
- Tuotteen kuvaus:
а) Yleisarvomäärä: Ruohonleikkuri б) Toiminto: Ruohon leikkaus
с) Tyyppi: д) Sarjanumero:
- Meludirektiivi:
а) Mitattu äänitehotaso - б) Taattu äänitehotaso - в) Meluparametrit: asennettu nettoteho
д) Vaatimustenmukaisuuden arviointimenettely - е) Ilmoitettu laitos
- Valmistaja:
- Teknisen dokumentaation laatinnut valmistajan edustaja:
- Viittaus yhdenmukaistettuihin standardeihin:
- Muut kansalliset standardit tai tekniset eritelmät:
Laadittu: Päivämäärä: Pääjohtaja: Allekirjoitus:

EC-Declaration of Conformity

- The undersigned, Mr Takayoshi Fukai, representing the manufacturer, herewith declares that the machinery described below complies with all the relevant provisions of the Machinery Directive 2006/42/EC - 98/37/EC. The machinery also complies with the provisions of the:
- outdoor noise Directive: 2000/14/EC - 2005/88/EC
- EMC Directive: 2004/108/EC
- Description of the machinery:
а) Generic denomination: Lawn mower
б) Function: Cutting of grass
с) Type: HRX426C (PDE, PXE, SDE, SXE, RXE, QXE),
HRX476C (PXE, SDE, SXE, HXE, QXE)
д) Serial number:

HRX426C	MATF	1110000 ~ 1142112
HRX476C	MASF	1130000 ~ 1175648
- Outdoor noise Directive
а) Measured sound power: 92 dB (A) (HRX426C)
93 dB (A) (HRX476C)
б) Guaranteed sound power: 94 dB (A) (HRX426C - HRX476C)
с) Noise parameter: L = 42 cm (HRX426C) - L = 47 cm (HRX476C)
д) Conformity assessment procedure: Annex VI
е) Notified body: CEMAGREF
Groupement d'Antony - Parc de Tourvois - BP 44
92163 ANTONY Cedex - France

Πιστοποιητικό συμμόρφωσης Ε.Ε.

- Ο υπογράφων, Takayoshi Fukai εκπροσωπώντας τον κατασκευαστή, δια του παρόντος δηλώνει ότι το μηχάνημα που αναφέρεται πιο κάτω βρίσκεται σε εναρμόνιση με τις προβλέψεις των οδηγιών της ΕΕ. Τα μηχανήματα βρίσκονται σε εναρμόνιση με τις προβλέψεις των:
- Οδηγιών θορύβου εξωτερικού χώρου:
- Οδηγίας EMC:
- Περιγραφή μηχανήματος:
а) Γενική ονομασία: Χλοοκοπτικό β) Λειτουργία: για κόψιμο γρασιδιού
γ) Τύπος: δ) Αριθμός παραγωγής:
- Οδηγία θορύβου εξωτερικού χώρου:
а) Ισχύς μετρηθέντος θορύβου - β) Εγγυημένο επίπεδο θορύβου - γ) Παραμέτροι θορύβου: ισχύς κινητήρα - δ) Διαδικασία αξιολόγησης συμμόρφωσης - ε) Όνομα κοινοποιημένου οργανισμού
- Κατασκευαστής:
- Εγγεκριμένος αντιπρόσωπος κανός για σύσταση τεχνικού συγγράμματος:
- Αναφορά σε εναρμονισμένα πρότυπα:
- Αναφορά σε άλλα εθνικά πρότυπα ή προδιαγραφές:
Η δοκιμή έγινε: Ημερομηνία: Πρόεδρος: Υπογραφή:

EK-Megfelelősségi nyilatkozat

- Alulírott Takayoshi Fukai, mint a gyártó képviselője nyilatkozom, hogy az alábbi berendezés mindenben megfelel a Gépekre irányuló rendelkezéseknek:
A berendezés megfelel a Külső Hangkibocsátási és a EMC Direktíváknak
- A gép leírása:
а) Általános megnevezés: Fűnyíró б) Funkció: Fű levágása
с) Típus: д) Sorozatszám:
- Külső hangkibocsátási előírások:
а) Mért hangerő б) Garantált hangerő в) Zaj paraméter: Üzembehelyezett zajszint
д) Beceklési eljárás megfelelőséghez е) Bejegyzett teszt
- Gyártó:
- Műszaki dokumentáció összeállítására jogosult képviselő:
- Hivatkozással a szabványokra:
- Más belföldi előírások, megjegyzések:
Keltezés helye: Keltezés ideje: Elnök: Alíráás:

Dichiarazione di conformità

- Il sottoscritto, Takayoshi Fukai in rappresentanza del costruttore, dichiara qui di seguito che la macchina sotto descritta è conforme con tutte le condizioni pertinenti della Direttiva Macchine. La macchina è anche conforme alle condizioni della:
 - Direttiva sulle emissioni acustiche delle macchine destinate a funzionare all'aria aperta:
 - Direttiva sulla compatibilità elettromagnetica:
 - Descrizione della macchina:**
 - Denominazione generica: Rasaerba
 - Funzione: Taglio di erba
 - Tip:
 - Numero di serie:
 - Direttiva emissioni acustiche:**
 - Livello di potenza sonora misurata - b) Livello di potenza sonora garantita
 - Parametri rumorosità: Potenza netta installata - d) Procedura di valutazione conformità
 - Organismo notificato
 - Costruttore:
 - Rappresentante Autorizzato idoneo a compilare la documentazione tecnica:
 - Riferimento agli standard armonizzati:
 - Altri standard o specifiche nazionali
- Fatto a: _____ Data: _____ Presidente: _____ Firma: _____

EB Atitikties Deklaracija.

- Žemiau pasirašes, p. Takayoshi Fukai atstovaujantis gamintoją, deklaruoja, kad įranga atitinka reikalavimus pagal direktyvą:
 - Mašinos aprašymas:**
 - Bendras pavadinimas: Vejapjovė
 - Funckija: Žolės pjovimas
 - Tipas:
 - Serijinis numeris:
 - Triukšmo direktyva:**
 - Išmatuotas triukšmo lygis - b) Garantuotas triukšmo lygis - c) Triukšmo parametrai: Nominali instaliuota galia - d) Atitikties įvertinimo procedūra - e) Atstovas.
 - Gamintojas:
 - Įgaliotas atstovas turintis techninę dokumentaciją:
 - Nuoroda į harmonizuotus standartus:
 - Kiti nacionaliniai standartai ir specifikacijos:
- Atlikta: _____ Data: _____ Prezidentas: _____ Parašas: _____

Declaração CE de conformidade

- O abaixo assinado, Takayoshi Fukai, representante do fabricante, declara que a maquinaria abaixo descrita cumpre com todas as normas referentes à Diretiva de Maquinaria. A maquinaria também cumpre as diretivas de:
 - Diretiva de ruído no exterior:
 - Diretiva EMC:
 - Descrição da maquinaria:**
 - Denominação genérica: Corta-relvas
 - Função: Corte de relva
 - Tip:
 - Número série:
 - Diretiva de ruído no exterior:**
 - Potência de som medida - b) Potência de som garantida - c) Parâmetros de ruído: d) Procedimento da avaliação da conformidade - e) Organismo notificado
 - Fabricante:
 - Representante autorizado e apto para confirmar a documentação técnica:
 - Referência aos padrões harmonizados:
 - Outras normas nacionais ou especificações:
- Feito em: _____ Data: _____ Presidente: _____ Assinatura: _____

Deklaracija zgodności wyrobu

- Niżej podpisany, Takayoshi Fukai reprezentujący producenta, deklaruje iż urządzenie opisane poniżej jest zgodne z wszystkimi zasadniczymi wymaganiami Dyrektywy Maszynowej. Urządzenie spełnia dodatkowo wymagania:
 - Dyrektywy Hałasowej:
 - Dyrektywy EMC:
 - Opis urządzenia:**
 - Ogólne określenie: Kosiarka
 - Funckija: Ścinanie trawy
 - Typ:
 - Numer seryjny:
 - Dyrektywa Hałasowa:**
 - Zmierzony poziom mocy akustycznej - b) Gwarantowany poziom mocy akustycznej
 - Parametry charakterystyczne: Zainstalowana moc netto
 - Zastosowana procedura oceny zgodności - e) Jednostka Notyfikowana
 - Producent:
 - Upoważniony Przedstawiciel posiadający dostęp do dokumentacji technicznej:
 - Zastosowane normy zharmonizowane:
 - Pozostałe normy i przepisy krajowe:
- Miejsce: _____ Data: _____ Prezes: _____ Podpis: _____

UE -Declaratie de Conformitate

- Subsemnatul Takayoshi Fukai, reprezentand producatorul, declara prin prezenta ca echipamentele mai descrise mai jos respecta toate prevederile relevante din Directiva privind echipamentele Echipamentele respecta de-asemenea prevederile Directivelor privind nivelul de zgomot exterior si Directiva EMC:
 - Descrierea echipamentului:**
 - Denumire generica: Cositoare gazon
 - Domeniu de utilizare: Tunderea ierbiilor
 - Tip:
 - Numar de serie:
 - Directiva privind zgomotul exterior:**
 - Puterea sonora masurata - b) Puterea sonora garantata - c) Parametrii de zgomot putere instalata neta - d) Procedura de evaluare a conformitatii - e) Organismul notificat
 - Producator:
 - Reprezentantul Autorizat in masura sa intocmeasca documentatia tehnica:
 - Referinta la standardele armonizate:
 - Alte standarde nationale sau specificatii:
- Emisa la: _____ Data: _____ Prezident: _____ Semnatura: _____

EG-deklaration för överensstämmande

- Undertecknad, Takayoshi Fukai, representant för tillverkaren, försäkras härmed att maskinerna beskrivna nedan uppfyller alla relevanta stadgar i Maskin Direktivet eller Maskinerna uppfyller också stadgarna för:
 - Utomhus bullerdirektiv:
 - EMC direktiv:
 - Maskinbeskrivning:**
 - Allmän benämning: Gräsklippare
 - Funckija: Gräsklippning
 - Typ:
 - Serie nummer:
 - Utomhus bullerdirektiv:**
 - Uppmätt ljudeffekt - b) Garanterad ljudeffekt - c) Bullerparameter: Installerad nettoeffekt
 - Utfärderingsprocedur för överensstämmande - e) Anmälda organ
 - Tillverkare:
 - Auktoriserad representant som kan sammanställa den tekniska dokumentationen:
 - Referens till överensstämmande standarder:
 - Andra nationella standarder eller specifikationer:
- Utfärdat vid: _____ Datum: _____ Ordförande: _____ Underskrift: _____

Vyhlasenie o súlade s predpismi ES

- Dolupodpísaný pán Takayoshi Fukai zastupujúci výrobcu týmto vyhlasuje, že stroje popísané nižšie vyhovujú všetkým relevantným predpisom smernice. Stroje vyhovujú predpisom:
 - EMC direktiva:
 - Popis strojov:**
 - Druhové označenie: Kosačky na trávu
 - Funckija: Kosenie tráv
 - Typ:
 - Sériové číslo:
 - Smernica emisii hluku vo voľnom priestranstve:**
 - Nameraný akustický tlak - b) Garantovaný akustický tlak - c) Parameter hluku: Nominálny čistý výkon - d) Proces posudzovania zhody - e) Notifikovaný orgán
 - Výrobca:
 - Autorizovaný zástupca schopný predložiť technickú dokumentáciu:
 - Referencia k harmonizovaným štandardom:
 - Ďalšie národné štandardy alebo špecifikácie:
- Miesto: _____ Dátum: _____ Predseda: _____ Podpis: _____

ES-izjava o skladnosti

- Spodaj podpisani, Takayoshi Fukai, ki predstavljam proizvajalca, izjavljam da so spodaj navedene naprave v skladu z direktivo. Naprave prav tako ustrezajo naslednjim direktivam:
 - Direktiva o hrupnosti:
 - EMC direktiva:
 - Opis naprave:**
 - Vrsta stroja: Vrtna kosilnica
 - Funckija: Košenje trave
 - Tip:
 - Serijska številka:
 - Direktiva o hrupnosti:**
 - Izmerjena zvočna moč - b) Garantirana zvočna moč - c) Parametri: Neto moč
 - Postopek meritve - e) Testiranje opravil
 - Proizvajalec:
 - Pooblaščen predstavnik, ki hrani tehnično dokumentacijo:
 - Upoštevanje harmonizirani standardi:
 - Ostali standardi:
- Kraj: _____ Dátum: _____ Predsednik: _____ Podpis: _____

EU samsvarserklæring

- Underteignede, Takayoshi Fukai representerer produsenten og erklærer herved at produktet beskrevet nedenfor er i samsvar med relevante forskrifter i Maskindirektivet. Produktet samsvarer også med forskrifter vedr:
 - rammedirektiv for utendørs støy.
 - EMC direktiv
 - Produktbeskrivelse:**
 - Felles benevnelse: Gressklipper
 - Funckija: Klippe gress
 - Typ:
 - Serienummer:
 - Rammedirektiv om utendørs støy:**
 - Målt lyd effekt - b) Garantert lyd effekt - c) Støyparameter: Netto installert effekt
 - Valgt samsvarsprosedyre - e) Teknisk kontrollorgan
 - Produsent:
 - Autorisert representant/innhaver av teknisk dokumentasjon:
 - Referanse til harmoniserte standarder:
 - Øvrige nasjonale standarder eller spesifikasjoner:
- Sted: _____ Dato: _____ Formann: _____ Underskrift: _____

4) **Manufacturer:**
Honda France Manufacturing S.A.S
Pôle 45 - Rue des Châtaigniers
45140 ORMES - FRANCE

5) **Authorized Representative able to compile the technical documentation:**
N/A

6) **Reference to harmonized standards**
EN836 : 1997 / AC : 2006
EN ISO 14982 : 1998

7) **Other national standards or specifications**
N/A

Done at: _____ Date: _____ President: _____ Signature: _____
ORMES 01 12 2009 Takayoshi Fukai 

EK Atbilstības deklarācija

- Zemāk minētais Takayoshi Fukai, kā ražotāja pārstāvis ar šo apstiprina, ka atrunātā iekārta pilnībā atbilst visiem standartiem, kas atrunāti EC-Direktīvā Kā arī šī iekārta atbilst:
 - trokšņa līmeņa direktīvai:
 - EMC direktīvai:
 - Lekārtas apraksts:**
 - Vispārējais nosaukums: Zāles pļāvējs
 - Funckija: Zāles pļaušana
 - Tip:
 - Sērijas numurs:
 - Trokšņa līmeņa direktīva:**
 - Nomērītā trokšņa jauda - b) Garantētā trokšņa jauda - c) Trokšņa parametri: Kopējā uzstādītā jauda - d) Atbilstības noteikšanas procedūra - e) Atbildīgā iestāde
 - Ražotājs:
 - Autorizētais pārstāvis, kas ir kompetents apkopot tehnisko dokumentāciju:
 - Atsaucošies uz saskaņotajiem standartiem:
 - Citi valsts noteiktie standarti vai specifikācijas:
- Vieta: _____ Datums: _____ Prezidents: _____ Paraksts: _____

EU-Conformiteitsverklaring

- Ondergetekende, Takayoshi Fukai, vertegenwoordiger van de constructeur, verklaart hierbij dat de hieronder beschreven machine in overeenstemming is met de bepalingen van de Veiligheidsrichtlijn voor machines. De machine voldoet eveneens aan de bepalingen van de richtlijnen voor geluidsemisie van materieel voor gebruik buitenshuis en elektromagnetisme.
 - Beschrijving van de machine:**
 - Algemene benaming: Gazonmaaier
 - Funckija: Gras maaien
 - Type:
 - Serienummer:
 - Geluidsemisie materieel voor gebruik buitenshuis:**
 - Gemeten geluidsvermogen - b) Gegarandeerd geluidsvermogen - c) Geluidsparameter: Geïnstalleerd vermogen - d) Conformiteitsbeoordelingsprocedure - e) In kennis gestelde instantie
 - Konstruktuer:
 - Vertegenwoordiger die gemachtigd is om de technische documentatie samen te stellen:
 - Verwijzing naar geharmoniseerde normen:
 - Andere nationale normen of technische specificaties:
- Opgemaakt te: _____ Datum: _____ President: _____ Handtekening: _____

HONDA
The Power of Dreams